

HART® Communicator

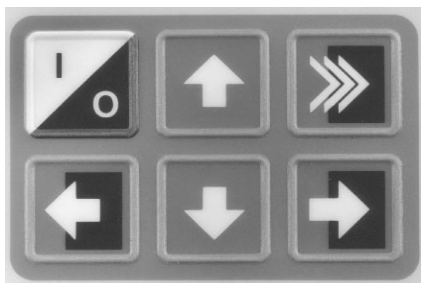

Product Manual for the HART Communicator

NOTICE

Read this manual before working with this product. For personal and system safety, and for optimum product performance, make sure you thoroughly understand the contents before using or servicing this product.

For equipment service needs, contact the nearest product representative.

Rosemount and SMART FAMILY are registered trademarks of Rosemount Inc.

MINIGRABBER is a trademark of Pomona Electronics.

HART is a registered trademark of the HART Communication Foundation.

Fisher-Rosemount

8301 Cameron Road

Austin, TX 78754 USA

Technical Support: 1-800-833-8314

or (512) 832-3774

Service: 1-800-654-7768

www.hartcommunicator.com

FISHER-ROSEMOUNT™

MAN 4275A00 AW# 000701

© Fisher-Rosemount Systems, Inc. 2000.

All Rights Reserved.

TABLE OF CONTENTS

The HART® Communicator.....	1-1
Introduction.....	1-1
HART Communicator Connections	1-2
Liquid Crystal Display (LCD)	1-5
The Action Keys	1-5
On/Off Key	1-5
Up Arrow Key	1-6
Down Arrow Key	1-6
Left Arrow and Previous Menu Key.....	1-6
Right Arrow and Select Key	1-6
Hot Key	1-6
Software-Defined Function Keys.....	1-6
Alphanumeric and Shift Keys	1-8
Using the Fast Select Feature.....	1-8
Using Shift Keys for Data Entry.....	1-9
Getting to Know the HART Communicator.....	1-9
Software Icons	1-10
Learning the Menu Structure.....	1-11
Reviewing Installed Devices	1-12
Main Menu.....	1-12
Offline Menu	1-13
New Configuration (Offline).....	1-14
From Blank Template Menu.....	1-15
Saved Configuration Menu (Offline).....	1-17
Data Pack Contents Menu	1-17
Saved Configuration Menu (data pack Contents)	1-18
Online Menu	1-19
Frequency Device Menu	1-22
Utility Menu.....	1-22
Configure Communicator Menu	1-22
Polling Menu	1-23
Contrast Menu.....	1-24
Off Time Menu	1-24
Ignore Diagnostics Menu	1-25

Delete Configs Menu.....	1-25
System Information Menu	1-26
Listen for PC Menu	1-26
Storage Location Menu	1-28
Simulation Menu	1-28
Saving a Connected Device Configuration.....	1-29
Using the Hot Key	1-30
Customizing the Hot Key Menu.....	1-31
Adding Options to the Hot Key Menu.....	1-31
Deleting Options from the Hot Key Menu.....	1-33
The HART Communicator and the Year 2000	1-34
Editing the Date.....	1-34
Servicing the HART Communicator	1-35
Calibrating the HART Communicator.....	1-35
Using a Battery Pack.....	1-35
Changing Alkaline Batteries	1-36
Recharging the Battery Pack	1-37
Using a Memory Module	1-37
Replacing the Memory Module	1-38
Installing and Removing the Data Pack 100	1-39

Common Tasks for Fisher-Rosemount HART

Devices	2-1
Introduction.....	2-1
Powering Up Online	2-1
Online Menu	2-2
Device Setup.....	2-2
Primary Variable (PV)	2-3
Analog Output (AO).....	2-3
Lower Range Value (LRV)	2-3
Upper Range Value (URV).....	2-3
Device Setup Menu	2-4
Process Variables	2-4
Diag/Service	2-4
Basic Setup	2-5
Detailed Setup.....	2-5
Review	2-6
Fast Key Sequences	2-6

Menu Trees.....	3-1
Introduction.....	3-1
Model 54pH/ORP Transmitter	3-2
Model 333 HART® Tri-Loop Converter.....	3-3
Model 644 Temperature Transmitter.....	3-4
Model 1151 Pressure Transmitter.....	3-5
Model 2081C Conductivity Transmitter.....	3-6
Model 2081pH Transmitter.....	3-7
Model 2088 Pressure Transmitter.....	3-8
Model 2090 Pressure Transmitter.....	3-9
Model 3001S Hydrostatic Transmitter.....	3-10
Model 3044C Temperature Transmitter.....	3-11
Model 3051 Pressure Transmitter.....	3-12
Model 3051C Pressure Transmitter (Original).....	3-13
Model 3081C Conductivity Transmitter.....	3-14
Model 3081FG Oxygen Analyzer.....	3-15
Model 3081pH Transmitter.....	3-16
Model 3095C Level Controller.....	3-17
Model 3095MV Multivariable Transmitter.....	3-18
Model 3144 Temperature Transmitter.....	3-19
Model 3201 Hydrostatic Interface Unit.....	3-20
Model 3202 Smart Application Module.....	3-21
Model 3244 Temperature Transmitter.....	3-22
Model 3680 Density Transmitter.....	3-23
Model 3809/3810 Variable Area Meter.....	3-24
Model 4000 Oxygen Analyzer.....	3-25
Model 8712C Mag Flow Transmitter.....	3-26
Model 8712C+ Mag Flow Transmitter.....	3-27
Model 8712U+ Mag Flow Transmitter.....	3-28
Model 8800 Vortex Flowmeter.....	3-29
Model 9701 Mass Flowmeter.....	3-30
Model 9712 Mass Flowmeter.....	3-31
Model 9739 Mass Flowmeter.....	3-32

Model APEX Radar Level Gauge	3-33
Model ProBar™ DP Flowmeter	3-34
Model ProBar™ UC Flowmeter	3-35
Model Tri-20/9000 Oval Flowmeter	3-36
Model WC3000 Oxygen Analyzer	3-37
HART Communicator Messages	A-1
Specifications and Ordering Information	B-1
Functional Specifications.....	B-1
Performance Specifications.....	B-2
Physical Specifications.....	B-2
Ordering Information	B-3
Spare Parts	B-4
CSA and FM Intrinsic Safety Approvals.....	C-1
Canadian Standards Association (CSA)	C-1
Factory Mutual (FM)	C-2
Troubleshooting Communication Problems	D-1
If you are still having problems.....	D-3
Index	I-1

LIST OF ILLUSTRATIONS

Figure Number	Title	Page
1-1.	The HART Communicator.	1-1
1-2.	Rear Connection Panel with NiCad Recharger Jack.	1-2
1-3.	Connecting to the Transmitter Comm Terminals.	1-3
1-4.	Connecting the HART Communicator to the Loop.	1-3
1-5.	Connecting the HART Communicator with the Load Resistor. ...	1-4
1-6.	HART Communicator Alphanumeric and Shift Keys.	1-8
1-7.	Quickly Accessing Menus.	1-8
1-8.	Powering Up Offline or Online.	1-10
1-9.	Menu Icons and Associated Keys.	1-10
1-10.	Main Menu.	1-12
1-11.	Offline Menu Tree.	1-13
1-12.	Offline Menu.	1-14
1-13.	From Blank Template Menu.	1-15
1-14.	Edit Individually Menu.	1-15
1-15.	Unit Variable Menu.	1-15
1-16.	Save As... Menu.	1-16
1-17.	Location Menu.	1-16
1-18.	Saved Configuration Menu (Offline).	1-17
1-19.	Data Pack Contents Menu.	1-17
1-20.	Saved Configuration Menu (data pack Contents).	1-18
1-21.	Online Menu.	1-19
1-22.	Generic Online Menu Tree.	1-21
1-23.	Frequency Device Menu.	1-22
1-24.	Utility Menu.	1-22
1-25.	Configure Communicator Menu.	1-22
1-26.	Polling Menu.	1-23
1-27.	Contrast Menu.	1-24
1-28.	Off Time Menu.	1-24
1-29.	Ignore Diagnostics Menu.	1-25

1-30. Delete Configurations Menu.	1-25
1-31. System Information Menu.	1-26
1-32. Listen for PC Menu.	1-26
1-33. Storage Location Menu.	1-28
1-34. Sample Hot Key Menu.	1-30
1-35. Hotkey Configuration Menu.	1-31
1-36. Adding a Hot Key Option.	1-32
1-37. Marking a Read-Only Hot Key Option.	1-32
1-38. Hot Key Menu.	1-32
1-39. Variable Display Option.	1-33
1-40. Deleting a Hot Key Option.	1-33
1-41. Date Menu.	1-34
1-42. HART Communicator Exploded View.	1-35
1-43. Battery Pack Removal.	1-36
1-44. Memory Module Replacement.	1-38
1-45. Data Pack 100 Installation and Removal.	1-39
2-1. Online Menu.	2-2
2-2. Device Setup Menu.	2-4
2-3. Diagnostics and Service Menu.	2-4
2-4. Basic Setup Menu.	2-5
2-5. Sample Fast Key Sequence.	2-6

LIST OF TABLES

Table Number	Title	Page
1-1.	Function Key Labels.	1-7
1-2.	Main Options for the PC AMS Interface.....	1-27

SECTION 1

The HART[®] Communicator

INTRODUCTION

The HART (Highway Addressable Remote Transducer) Communicator (**Figure 1-1**) is a hand-held interface that provides a common communication link to all HART-compatible, microprocessor-based instruments.

Section 1 discusses the HART Communicator Connections, Liquid Crystal Display, Keypad, Offline and Online menu, Battery Pack, Memory Module, data pack 100, Maintenance, and Year 2000 Compatibility. It also includes short overviews on some of the Communicator's functionality.

Section 2 describes tasks that are common to Fisher-Rosemount's HART devices and includes some of the common screen displays.

Section 3 displays typical examples of menu trees specific to Fisher-Rosemount products.

Your HART Communicator interfaces with any HART-compatible device from any wiring termination point using a 4–20 mA loop, provided a minimum load resistance of 250 ohms is present between the Communicator and the power supply. Your HART Communicator uses the Bell 202 frequency shift key (FSK) technique of high-frequency digital signals superimposed on a standard transmitter current loop of 4–20 mA. Because the total high-frequency signal voltage added to the loop amounts to zero, communication to and from a HART-compatible device does not disturb the 4–20 mA signal.

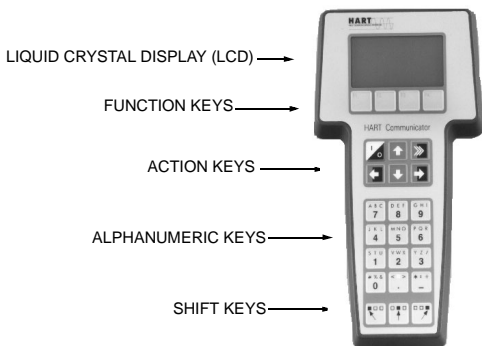

FIGURE 1-1. The HART Communicator.

HART COMMUNICATOR CONNECTIONS

The HART Communicator can interface with a transmitter from the control room, the instrument site, or any wiring termination point in the loop through the rear connection panel (**Figure 1-2**).

To interface, connect the HART Communicator with the appropriate connectors in parallel with the instrument or load resistor. All connections are non-polarized. When connecting to a PC, you must use the PC Communication Adapter to connect to the Communicator's serial port. See **Listen for PC Menu on page 1-26** for more information and **Appendix B** for a complete list of parts.

For intrinsically safe Canadian Standards Association (CSA) and Factory Mutual (FM) wiring connections, see **Appendix C**.

WARNING

Explosions can result in death or serious injury. Do not connect to the serial port or NiCad recharger jack in an explosive atmosphere.

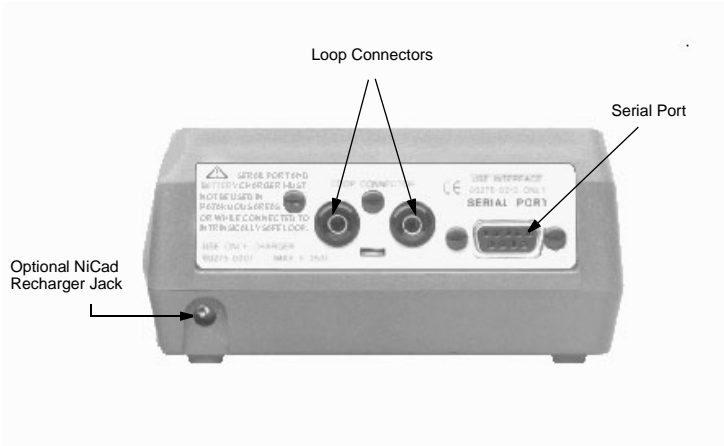

FIGURE 1-2. Rear Connection Panel with NiCad Recharger Jack.

NOTE: For the HART Communicator to function properly, a minimum of 250 ohms resistance *must be* present in the loop. The HART Communicator does not measure loop current directly.

Figure 1-3 and **Figure 1-4** illustrate typical wiring connections between the HART Communicator and any compatible device.

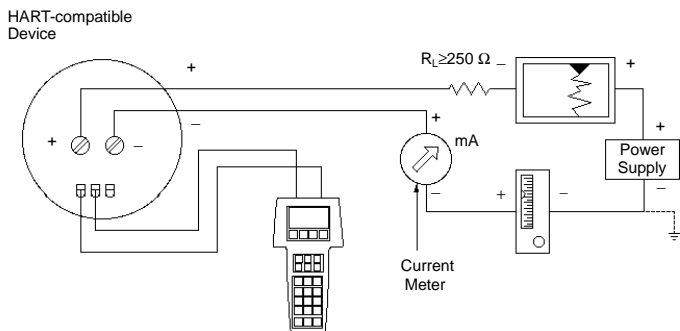

FIGURE 1-3. Connecting to the Transmitter Comm Terminals.

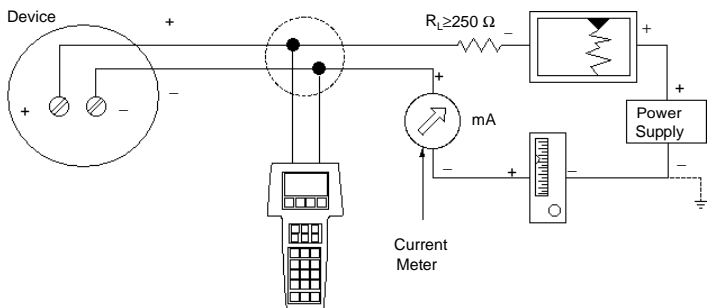

FIGURE 1-4. Connecting the HART Communicator to the Loop.

⚠ WARNING

Explosions can result in death or serious injury. Before connecting the HART Communicator in an explosive atmosphere, make sure the instruments in the loop are installed in accordance with intrinsically safe or nonincendive field wiring practices. For intrinsically safe CSA and FM wiring connections, see Appendix C.

Figure 1-5 shows how to connect the optional 250 ohm load resistor.

NOTE: To temporarily install the optional 250 ohm Load Resistor:

1. Insert the load resistor into the lead set jacks.
2. Open the loop to allow connection of the resistor in series in the loop.
3. Close the loop using the lead set connectors.

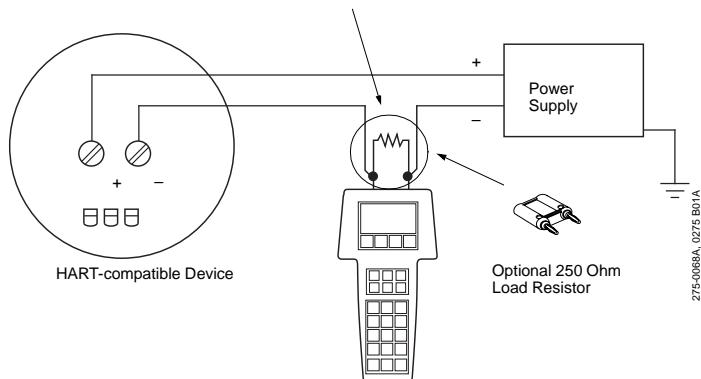

FIGURE 1-5. Connecting the HART Communicator with the Load Resistor.

LIQUID CRYSTAL DISPLAY (LCD)

The LCD is an 8-line by 21-character display that provides communication between you and the connected device. When you connect to a HART-compatible device, the top line of each Online menu displays the model name of the device and its tag. The bottom line of each menu is reserved for the dynamic labels for each software-defined function key, F1-F4 (found directly below the display).

These dynamic labels display available functions. For example, the label **HELP** appears above the F1 key when access to online help is available. See **Software-Defined Function Keys on page 1-6** for more information.

The Communicator does not store key strokes in its memory. The LCD should be fully displayed before you press a key to do the next action.

THE ACTION KEYS

The action keys (**Figure 1-1**) are the six blue, white, and black keys located above the alphanumeric keys. The function of each key is described as follows:

On/Off Key



Use this key to power up and power off the HART Communicator.

When you power up the Communicator, it automatically searches for a HART-compatible device on the 4-20 mA loop. If a device is not found, the Communicator displays the message “No Device Found. Press OK....” Press the OK ‘F4’ function key and the Main menu displays on the screen. See **Main Menu on page 1-12**.

If a HART-compatible device is found, the Communicator displays the Online menu. See **Online Menu on page 1-19**.

Refer to **Getting to Know the HART Communicator on page 1-9, Section 3**, or your device-specific manual for more information about Online menu options.

You can select the Polling option to direct the HART Communicator to look for devices at multidrop addresses. See **Polling Menu on page 1-23** for details.

During certain operations, the message “OFF KEY DISABLED” indicates that you cannot turn the HART Communicator off. This feature helps you avoid unintentionally turning off the power to the HART Communicator while the output of a device is fixed or when you are editing a device variable.

Up Arrow Key



Use this key to move the cursor up through a menu or list of options. You can also use it to scroll through lists of available characters when editing fields that accept both alpha and numeric data.

Down Arrow Key



Use this key to move the cursor down through a menu or list of options. You can also use it to scroll through lists of available characters when editing fields that accept alpha and numeric data.

Left Arrow and Previous Menu Key



Use this dual-function key to move the cursor to the left or back to the previous menu.

Right Arrow and Select Key



Use this dual-function key to move the cursor to the right or to select a menu option.

Hot Key



Use this key to quickly access important, user-defined options when connected to a HART-compatible device. When the HART Communicator is turned off, press the Hot Key to automatically power up and display your predefined Hot Key menu. When powered up online, press the Hot Key to immediately display the Hot Key menu.

See **Using the Hot Key on page 1-30** for more information.

SOFTWARE-DEFINED FUNCTION KEYS

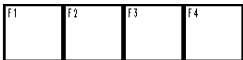

Use the four software-defined function keys located below the LCD, marked F1 through F4, to perform software functions as indicated by the dynamic labels. On any menu, the label appearing above a function key indicates the function of that key for the current menu. As you move among menus, different function key labels appear over these four keys. For example, in menus providing access to online help, the **HELP** label appears above the F1 key.

In menus providing access to the Home menu, the **HOME** label appears above the F3 key. When the **HOME** label displays, press F3 to return directly to the Online menu. Press **BACK** (F3) to return to the screen from which **HOME** was pressed.

Table 1-1 describes the labels that appear above each function key throughout the various Communicator menus.

TABLE 1-1. Function Key Labels.

F1	F2	F3	F4
HELP Access online help	ON/OFF Activate or deactivate a bit-enumerated binary variable	ABORT Terminate current task	OK Acknowledge information on screen
RETRY Try to re-establish communication	DEL Delete current character or Hot Key menu item	ESC Leave a value unchanged	ENTER Accept user-entered data
EXIT Leave the current menu	SEND Send configuration data to device	QUIT Terminate session because of a communication error	EXIT Leave the current menu
YES Answer yes/no question	PGUP Move up one help screen	PGDN Move down one help screen	NO Answer yes/no question
ALL Include current Hot Key item on Hot Key menu for all devices	PREV Go to previous message in a list of messages	NEXT Go to next message in a list of messages	ONE Include Hot Key item for one device
NEXT Go to the next variable in offline edit	SAVE Save information to Memory Module or data pack	HOME Go to the top menu in the device description	
FILTR Open customization menu to sort configurations	MARK Toggle marked configuration variables for sending to a field device	BACK Go back to the menu from which HOME was pressed	
	XPAND Open detailed configuration information	EDIT Edit a variable value	
	CMPRS Close detailed configuration information	ADD Add current item to Hot Key menu	

ALPHANUMERIC AND SHIFT KEYS

The 12 alphanumeric keys (**Figure 1-6**) perform two functions — the fast selection of menu options and data entry. Three shift keys enable use of the upper row of characters on each alphanumeric key.



FIGURE 1-6. HART Communicator Alphanumeric and Shift Keys.

Using the Fast Select Feature

From within any menu, you can select available options in two ways: 1) you can use the up and down arrow keys and the select key to access available options, 2) you can use the fast select feature. To fast select the desired option, press the corresponding number on the alphanumeric keypad.

Figure 1-7 shows how to quickly access the Utility menu from the Main menu by pressing the indicated fast key.

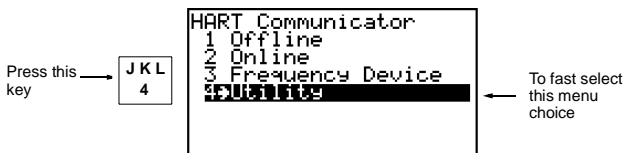

FIGURE 1-7. Quickly Accessing Menus.

Using Shift Keys for Data Entry

Some menus require data entry. Use the up and down arrow keys when available, or use the alphanumeric and shift keys to enter the alphanumeric information into the HART Communicator.

If you press only the alphanumeric key within an edit menu, only the bold character in the center of the key will display. These large characters include the numbers zero through nine, the decimal point (.), and the dash symbol (-). To enter the other characters on the keys, first press and release the shift key corresponding to the position of the desired character on the key and then press the alphanumeric key. Do not press the keys simultaneously. For example, to enter the letter “R” press the following key sequence:



Press the right shift key to activate the shift function; the right shift arrow icon appears in the upper right corner of the display. With right shift activated, press the **6** key; an “R” appears in the editable field. Press the shift key again to deactivate the shift function.

GETTING TO KNOW THE HART COMMUNICATOR

The HART Communicator is generally used in two environments — offline (not connected to a device) and online (connected to a device). The first menu displayed when you power up the Communicator is different for offline and online.

Powering up the Communicator when it is not connected to a device displays the message “No Device Found.” Press OK and the Main menu appears. Powering up the Communicator when it is connected to a device displays the Online menu for the device. From the Online menu, you can access the Main menu by pressing the left-arrow key. See **Figure 1-8**.

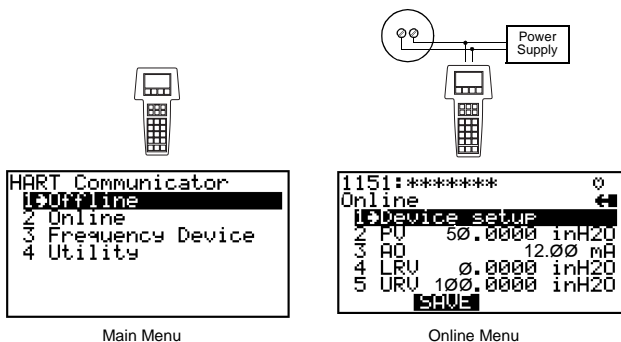

FIGURE 1-8. Powering Up Offline or Online.

Software Icons

The HART Communicator menus display icons that represent specific keys on the keypad. **Figure 1-9** shows examples of these.

HART communication:
 Blinking indicates ongoing communications (HART messages are presently being transmitted or received).
 Blinking indicates the device is configured in the burst mode.

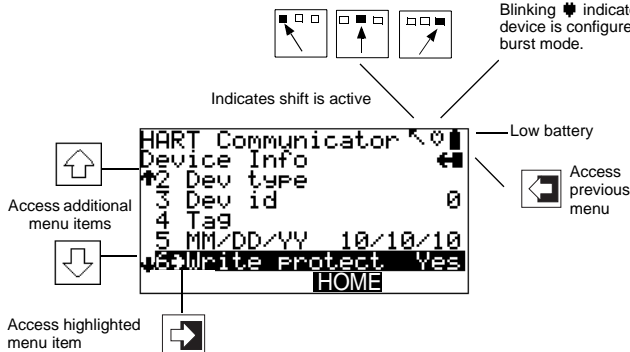



FIGURE 1-9. Menu Icons and Associated Keys.

Learning the Menu Structure

The following steps show you how to power up the Communicator *offline*, move through the menu structure, and then turn off the Communicator:

- 1 Turn the HART Communicator on.





- 2 Access the Utility menu by pressing  three times and then pressing .

```
HART Communicator
1 Offline
2 Online
3 Frequency Device
4 Utility
```

- 3 Access the Configure Communicator menu from the Utility menu by pressing .

```
HART Communicator
Utility
1 Configure Communicator
2 System Information
3 Listen for PC
4 Storage Location
5 Simulation
```

- 4 Access the Contrast menu by pressing  once and then pressing .

```
HART Communicator
Configure Communicator
1 Polling
2 Contrast
3 Off time
4 Ignore diagnostics
HELP
```

- 5 Press **ESC** (F3) to return to the Configure Communicator menu.

```
HART Communicator
Contrast
Use up/down arrows to
change contrast.
Press ENTER when
done.
ESC ENTER
```

- 6 Press  two times to return to the Main menu.

- 7 Turn the HART Communicator off.





Reviewing Installed Devices

The HART Communicator Memory Module contains device descriptions for specific HART-compatible devices. These descriptions enable the Communicator to recognize particular devices. The device types can be found in the Offline menu under New Configurations.

If you cannot find a specific HART-compatible device on your Communicator, the device revision you are looking for is not programmed into the Memory Module. In this instance, you are limited to what is available using the generic interface built into your HART Communicator.

To review the device descriptions programmed into your HART Communicator:

1. From the Main menu, press  to access Offline menu.
2. From the Offline menu, press  to access the list of device descriptions programmed into your HART Communicator. The Manufacturer menu displays a list of each manufacturer with device descriptions currently installed in your Communicator's Memory Module. The standard 12 MB Memory Module is recommended, as it allows for more device descriptions.
3. Select a manufacturer, and the Model menu displays, containing a list of currently installed device models provided by the selected manufacturer.
4. Review the different manufacturers and models to determine the installed HART-compatible devices in your Communicator.

MAIN MENU

If the HART Communicator is powered up when it is not connected to a device, the first menu to appear after the "Device Not Found" message is the Main menu (**Figure 1-10**).

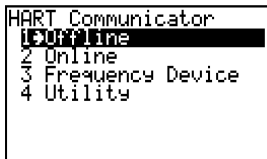

FIGURE 1-10. Main Menu.

If the Communicator is powered up when it is connected to a device, you can access the Main menu by pressing the previous menu key. Depending on the current online menu, you may need to press the previous menu key

several times or the **HOME** key plus  to return to the Main menu.

OFFLINE MENU

From the Main menu, press 1 to access the Offline menu. From the Offline menu you can access the options: New Configuration and Saved Configuration. **Figure 1-11** shows a menu tree for the Offline functions.

A HART-compatible device does not have to be connected to use the offline options, except when sending saved configuration data to a connected device.

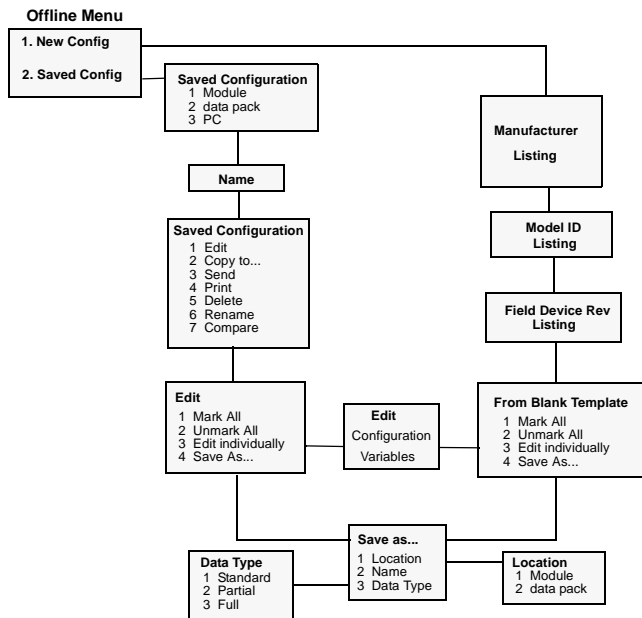



FIGURE 1-11. Offline Menu Tree.

New Configuration (Offline)

Use this option to compile a custom set of device configuration data for downloading to any HART-compatible device. You can download repeatedly to multiple devices so that they store identical configuration data.

Offline configuration may not be available for all devices. Steps 2 and 3 below will help you verify if the desired manufacturer and device model are programmed into the Communicator's Memory Module.

1. Press  on the Main menu to access the Offline menu. This menu allows you to enter a new device configuration or edit a saved device configuration.

To enter a new configuration, go to Step 2.

To edit a saved configuration, press **2** and go to **Saved Configuration Menu (Offline) on page 1-17**.



FIGURE 1-12. Offline Menu.

2. From the Offline menu, press **1**. The Manufacturer menu displays a list of manufacturers with device descriptions currently installed in your HART Communicator.
3. Select a manufacturer; the Model menu displays. The Model menu contains a list of the currently installed device models provided by the manufacturer.
4. Select a device model for configuration; the Field Device Revision (Fld dev rev) menu displays. The Fld dev rev menu contains the currently installed software revisions for the field device and device descriptions (DD) for the model you selected from the previous screen.
5. Select a device revision; the From Blank Template menu (**Figure 1-13**) displays.

If you are unsure of the device revision, connect the HART Communicator to the device and determine its device revision level. You can access this information from the Online menu>Device Setup>Detailed Setup>Device Information. See your device manual for more information.

From Blank Template Menu

To access From Blank Template Menu, see steps 2 through 5 under **New Configuration (Offline)** on page 1-14.

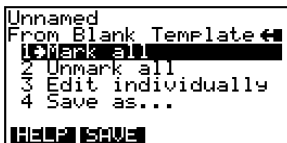

FIGURE 1-13. From Blank Template Menu.

The following options are available from the From Blank Template menu:

Mark all flags all configurable variables to be sent to a HART-compatible device. Configuration variables are those that appear when you edit variables in the configuration using the Edit Individually option.

Unmark all removes the flags from all configurable variables in the configuration. Unmarked configuration variables are not sent to a connected HART-compatible device.

Edit individually (Figure 1-14) opens the Edit Individually menu containing numerous configuration variables.

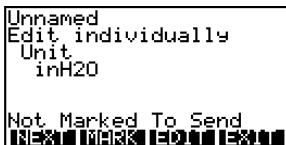

FIGURE 1-14. Edit Individually Menu.

For example, to change the engineering units from inH20 to ftH20, find the configuration variable, press the Edit function key, highlight the new unit, and press the **ENTER** function key. The Esc key returns you to the previous screen as displayed in Figure 1-15. When you are done, press the **EXIT** function key to return to the From Blank Template menu.

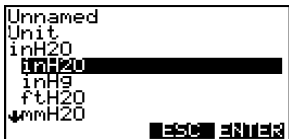

FIGURE 1-15. Unit Variable Menu.

Save as... saves your new configuration to either the Memory Module or the data pack 100. See **Figure 1-16** and **Figure 1-17**. The Memory Module holds up to 10 typical configurations, and contains the operating system software, and device application software in nonvolatile memory. The data pack stores up to 100 typical configurations in nonvolatile removable memory.



FIGURE 1-16. Save As... Menu.

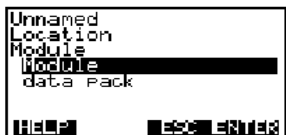

FIGURE 1-17. Location Menu.

You can also use the Save As... menu to enter or edit the configuration name and data type. Data Type Standard provides a Data Type menu with editable options. **Standard** is the set of editable variables used when defining a new device configuration. **Partial** is a set of marked variables. **Full** is the set of all device variables.

NOTE: Configurations created offline in the HART Communicator will not transfer to Asset Management Solutions (AMS) software; however, 'Full' configurations saved from a field device to a HART Communicator may be uploaded to AMS. Configurations saved as 'Full' from an online device may also be transferred directly to AMS.

After you have made all desired changes, save your new configuration to a storage location and return to the Offline menu. Refer to **Storage Location Menu on page 1-28** for more information.

Saved Configuration Menu (Offline)

You can access configuration data already stored in your Communicator through the offline Saved Configuration menu.

To access configuration data stored in your HART Communicator:

1. Press **1** on the Main menu to access the Offline menu.
2. Press **2** from the Offline menu, and the Saved Configuration menu screen displays (**Figure 1-18**).



FIGURE 1-18. Saved Configuration Menu (Offline).

3. Select either Module Contents or data pack Contents, as appropriate, to open your stored configurations. Both storage locations list all saved configurations by assigned Tag. See **Xpand on page 1-18** for more configuration identification details.

The PC option is not operational with this release. Refer to **Listen for PC Menu on page 1-26** for details on interfacing with a PC.

Data Pack Contents Menu

Figure 1-19 shows the data pack Contents menu, displaying a listing of device configurations stored in the data pack. From the Saved Configuration menu (**Figure 1-18**), press **2** to access the data pack Contents menu.



FIGURE 1-19. Data Pack Contents Menu.

The following functions keys are available from the data pack Contents menu:

The **FILTR** function key opens a menu that provides Sort and Filter options for customizing your view of saved device configurations. **Sort** lets you group and display device configurations according to your choice of Tag, Descriptor, or Name. **Tag Filter** lets you view information according to what

you entered with Sort by picking characters from the device Tag, Descriptor, or Name.

When setting up a filter, you can use the period (.) to replace a single character of any value or the asterisk (*) to replace zero or more alphanumeric characters of any value.

For example, if you enter **A-*-1**, it should match all device tags starting with **A-**, followed by any **characters**, followed by **-**, followed by any **single character**, and ending with a **1**. That means only devices starting with **A-** and ending in **1**, out of your list of saved device configurations, will display as a group on the Communicator's screen.

The **XPAND** function key allows you to view the Tag, Descriptor, and Name for the current configuration. Select Compress to return to the previous compressed screen with the current Tag or Descriptor or Name.

Saved Configuration Menu (data pack Contents)

From the data pack Contents menu (Figure 1-19), press  to open the Saved Configuration menu (Figure 1-20).

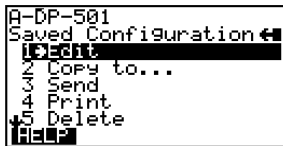

FIGURE 1-20. Saved Configuration Menu (data pack Contents).

The following functions are available from the Saved configuration menu:

Edit displays the Edit menu. These edit functions are the same as described under **Edit individually on page 1-15**. If you are editing online, remember that only stored data can be edited. A Partial configuration can be edited, but you must convert it to a Standard configuration in order to save your edits.

Copy to... specifies the storage location where you want the copy to be stored. You can also change the configuration name when using this option.

Send sends your saved configuration to a connected device.

Print requires AMS running in your computer. This option is intended for the future. See **Listen for PC Menu on page 1-26** for more information.

Delete removes a saved configuration from the memory storage location. A confirmation message will appear. Press Yes or No to complete the function.

Rename accesses the Configuration Name editing menu. After making name changes, enter and save the data to return to the previous storage location menu.

Compare compares a selected device configuration from a stored location with another device configuration. The HART Communicator compares device types, variables, marked lists, etc. Messages will appear indicating whether the configurations compared are the same or different. Press OK to return to the storage location and your list of device configurations. Find and make any necessary changes resulting from your comparisons.

In order to produce a “Same / Differ” result, the following conditions must be met when comparing two configurations:

1. Device type (including manufacturer), device type number, device revision, and DD revision must match exactly.
2. Configurations can only be compared against other configurations containing the same set of variables. The Communicator will notify you if this condition is not met.
3. The format of data storage must match exactly. The Communicator will notify you if this condition is not met.

User assigned configuration names are not considered, as they will differ.

ONLINE MENU

With a HART-compatible device connected, press VWX
2 on the Main menu to access the Online menu (**Figure 1-21**).

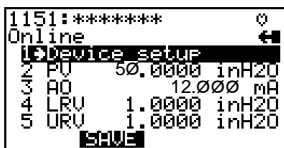

FIGURE 1-21. Online Menu.

The Online menu displays the name of the device on the first line of the LCD. You have complete functionality for a specific device only when that device description is present in the HART Communicator. If the DD is not present in the HART Communicator, contact your nearest service representative.

The Online menu can be different depending on the connected device. See your device-specific manual for Online menu details. Or, see **Section 3** for a selection of device-specific menu trees.

When the DD for a specific device is not available, your HART Communicator provides a generic interface. This generic interface enables you to perform functions common to all HART-compatible devices.

Figure 1-22 shows the Generic Online menu tree.

The Online (Generic) menu is the first menu in the generic interface. This menu displays critical, up-to-date device information such as the process variable (PV), analog output (AO), lower range value (LRV), and upper range value (URV). Configuration parameters for the connected device are accessed using the Device setup option.

The following functions are available from the Generic Online menu:

The **SAVE** function key allows you to save a configuration from a transmitted device. See **Changing a Saved Configuration on page 1-29** for more details.

Device Setup accesses the Device Setup menu, containing configurable device parameters common to all HART-compatible devices.

PV (Primary Variable) displays the dynamic PV and the related engineering units. When the PV contains too many characters to display on the Online menu, press **1** to access the PV menu and view the PV and related engineering units.

AO (Analog Output) and related engineering units are displayed on the Online menu. The AO is the signal on the 4–20 mA scale that corresponds to the PV. When the analog output contains too many characters to display on the Online menu, press **3** to access the PV AO menu and view the AO output and related engineering units.

Current **LRV** (Lower Range Value) and related engineering units are displayed on the Online menu. When the LRV contains too many characters to display on the Online menu, press **4** to access the PV LRV menu and view the LRV and related engineering units.

Current **URV** (Upper Range Value) and the related engineering units are displayed on the Online menu. When the URV contains too many characters to display on the Online menu, press **5** to access the PV URV menu and view the URV and related engineering units.

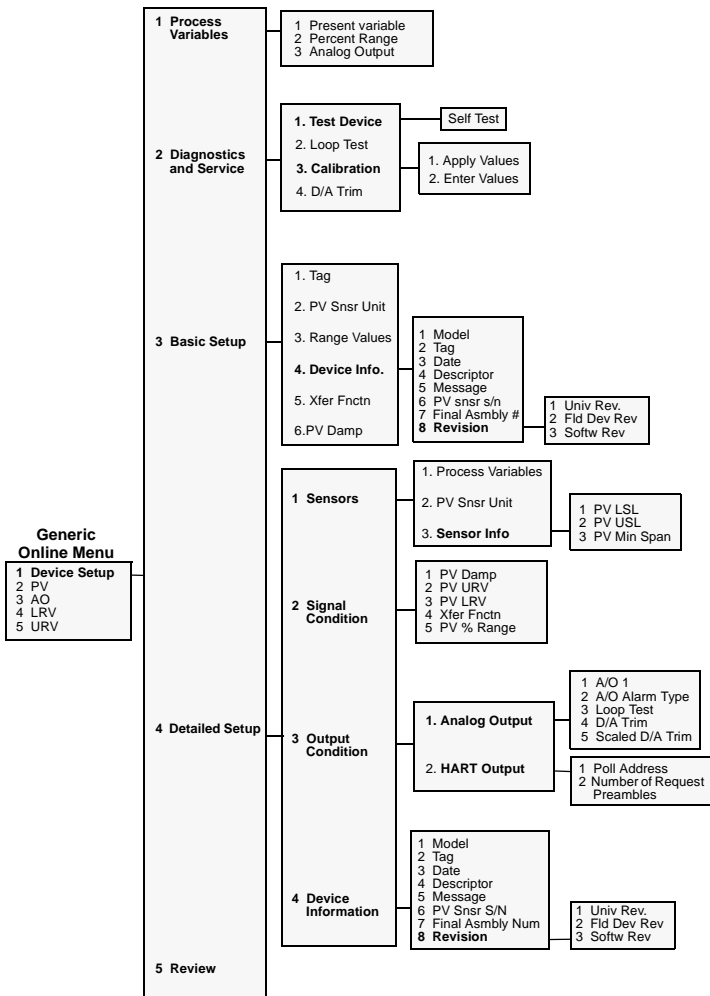



FIGURE 1-22. Generic Online Menu Tree.

FREQUENCY DEVICE MENU

From the Main menu, press  to access the Frequency Device menu (**Figure 1-23**). This menu displays the frequency output and corresponding pressure output for the current-to-pressure devices. The output shown below was taken from device Model 3311.

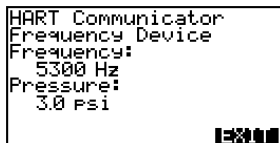



FIGURE 1-23. Frequency Device Menu.

UTILITY MENU

From the Main menu, press  to access the Utility menu (**Figure 1-24**). The Utility menu provides access to functions that affect only the operation of the HART Communicator.

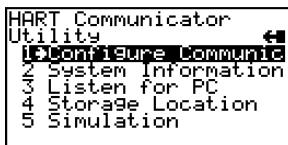

FIGURE 1-24. Utility Menu.

Configure Communicator Menu

From the Utility menu, press **1** to access the Configure Communicator menu (**Figure 1-25**). Use this menu to set the polling, adjust the LCD contrast, set the Communicator off time, or set the number of ignore diagnostics messages.

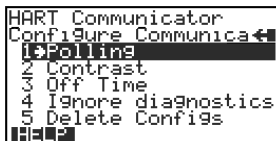

FIGURE 1-25. Configure Communicator Menu.

Polling Menu

Use the Polling options to configure your HART Communicator to automatically search for all or specific connected devices. The HART protocol allows you to communicate with multiple HART devices on a single twisted pair of wires over leased telephone lines.

When several devices are connected in the same loop (multidropped), each device must be assigned a unique address. To find the individual device addresses, use the Digital Poll option to find each connected device in the loop and list them by tag number.

Communication between the Communicator and multidropped transmitters is digital, with the analog output fixed. In a multidrop installation, each transmitter is identified by a unique polling address of 0 or 1–15 and responds to the commands defined in the HART protocol.

Use the up and down arrow keys to highlight the desired polling option: Press **ENTER** (F4) to enter the highlighted option and return to the Configure Communicator menu. Or, press **ESC** (F3) to return to the Configure Communicator menu without changing the Polling.

From the Configure Communicator menu (**Figure 1-25**), press

STU
1

 to access the Polling menu (**Figure 1-26**).

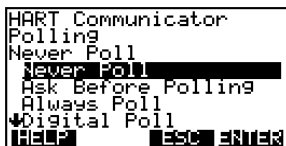

FIGURE 1-26. Polling Menu.

The Polling options are:

Never Poll connects to a device at address 0, and if not found, will not poll for devices at address 1–15.

Ask Before Polling connects to a device at address 0, and if not found, asks if you want to poll for devices at address 1–15.

Always Poll connects to a device at address 0, and if not found, will automatically poll for devices at address 1–15.

Digital Poll automatically polls for devices at address 1–15, regardless.

Poll Using Tag asks the user for a tag to use to connect to a device.

Refer to your device-specific manual for more information on changing a device polling address.

Contrast Menu

The Contrast menu adjusts the contrast on the LCD. However, the first time you reset and save the contrast, it is entered permanently. When you turn the Communicator off, then on, the adjusted setting will reappear. If you need help, call your service center for assistance.

Follow these steps to adjust the contrast:

1. From the Configure Communicator menu, press **VWX 2** to access the Contrast menu (**Figure 1-27**).



FIGURE 1-27. Contrast Menu.

2. Follow the on-screen instructions to adjust the display contrast. Press **ESC** (F3) to return to the Configure Communicator menu without adjusting the contrast. To save the changes to the contrast, press **ENTER** (F4) and the Configure Communicator menu displays.

Off Time Menu

Off Time is the amount of time that elapses before your HART Communicator turns off automatically when not in use. Use the following steps to set the automatic turn off option:

1. From the Configure Communicator menu, press **YZ/ 3** to access the Off Time menu (**Figure 1-28**).



FIGURE 1-28. Off Time Menu.

2. Use the numeric keys to select the automatic turnoff time or press **ESC** (F3) to return to the Configure Communicator menu without adjusting the off time.

- To save the off time change, press **ENTER** (F4) and the Configure Communicator menu displays.

Entering Zero (0) will disable this option. The maximum time allowed is 255 minutes. However, be aware that no information will be received about the improper operation of a field device when the Communicator is turned off.

Ignore Diagnostics Menu

The HART Communicator is designed to display diagnostic messages from a connected device. The Ignore diagnostics option allows you to specify the number of ignored messages, extending the time between displayed messages. This count will default to a nominal count of 50 out of a range of 50–500 each time the Communicator is turned on (**Figure 1-29**).



FIGURE 1-29. Ignore Diagnostics Menu.

Delete Configs Menu

The HART Communicator is capable of storing configurations in the Memory Module or data pack. You can also add items to the Hotkey menu. The Delete Configs menu allows you to delete in one step all configurations saved in the module or data pack, as well as to delete all menu items added to the Hotkey menu.

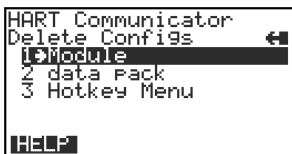

FIGURE 1-30. Delete Configurations Menu.

System Information Menu

From the Utility menu, press VWX
2 to access the System Information menu (Figure 1-31).



FIGURE 1-31. System Information Menu.

Motherboard system information consists of the Serial Peripheral Interface Time (SPI Time) and the firmware revision number.

Module system information consists of hardware and software data. For example, you can find the hardware revision, RAM size, and Flash size; or, the different software revisions and binary sizes.

data pack system information consists of the EEPROM size and revision number.

Listen for PC Menu

From the Utility menu, press YZ/
3 to access the Listen for PC menu (Figure 1-32).

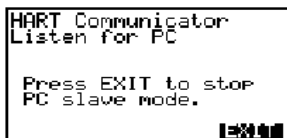

FIGURE 1-32. Listen for PC Menu.

The Listen for PC menu allows you to set up your HART Communicator so it can accept data transfer and requests from the PC. On the PC side, you must be running Asset Management Solutions (AMS) software. If AMS is installed, you can upload and download the device configuration information. Accessing data stored in the HART Communicator from the connected PC is a convenient way to view, compare, copy, and reconfigure field device configurations.

Follow these steps to connect your HART Communicator to a PC:

1. Plug the PC Communication Adapter into the 9-pin Serial Port located on the back of the Communicator. Refer to **Appendix B** for an illustration of the PC Communication Adapter and the Communicator.
2. Plug the PC 25-pin Serial Port cable into the other end of the PC Communication Adapter.
3. Connect the PC's Serial Port cable to the back of the PC. Depending on the PC, you must have either a 9-pin or 25-pin plug on the PC end of the cable to connect to the PC.
4. Set the Communicator to Listen for PC.
5. Move to the PC keyboard. All communication between the two systems is initiated at the PC.
6. Start the AMS application and select the HART Communicator icon to start communication. **Table 1-2** describes the main interface options selectable by right-clicking the Communicator icon in AMS. Refer to the AMS application online help system for details.

NOTE: AMS must also be configured appropriately to communicate with the HART Communicator. See the AMS User's Guide for details.

TABLE 1-2. Main Options for the PC AMS Interface.

Main Option	Description
Open and close the connection to the HART Communicator.	Opens or closes the table of contents located in the HART Communicator. This TOC is only a list of the configurations and includes partial configurations. It does not contain the configuration parameters. The configurations are listed by name, tag, or description and are grouped according to location: Memory Module or data pack.
Optimize memory in the HART Communicator.	Compresses the memory in the HART Communicator's Memory Module and data pack. It helps avoid "out of memory" conditions when loading device configurations into the Communicator.
View and change HART Communicator properties.	Displays a property sheet where you can set the PC-to-Communicator operation options or check on resources, version number, and available memory.
Move data between the HART Communicator, connected devices, and the AMS database.	Allows you to copy, cut, paste, and drag/drop icons as well as move device configurations from the HART Communicator to a connected device or to another area in the database.
Print device configuration.	Allows you print out the device configuration parameters using the File menu Print command.

Storage Location Menu

From the Utility menu, press **4** to access the Storage Location menu (**Figure 1-33**). The Storage Location menu allows you to access the Memory Module or data pack memory permanent storage locations.



FIGURE 1-33. Storage Location Menu.

The PC option requires AMS software running in your computer. Refer to **Listen for PC Menu on page 1-26** for more information.

When either the Memory Module or data pack storage locations are opened, you can use the Label submenu to view or edit the assigned name of the label given to the selected storage location. Or, with the Space Usage submenu, you can view the total memory and amount of free memory for the storage location.

Simulation Menu

The HART Communicator provides a simulation mode that allows you to simulate an online connection to a HART-compatible device without connecting the device. The simulation mode is a training tool that enables you to become familiar with different devices before configuring them in a critical environment. A simulated configuration cannot be saved, however.

To simulate an online connection from the Main menu:

1. From the Utility menu, press

MNO
5

 to access the Simulation menu. See **Utility Menu on page 1-22**. The Manufacturer menu displays a list of manufacturers with device descriptions currently installed in your Communicator.
2. Select a manufacturer. The Model menu displays, containing a list of currently installed device models provided by the selected manufacturer.
3. Select the device you want to simulate. The Fld dev rev menu displays, containing the current field device revisions for the selected model.

4. To access the main configuration menu, select the applicable device revision. The Online menu for the simulated device is displayed. You can now use the HART Communicator as if it were connected to the selected device, and perform any online task.

If you are unsure of the device revision, connect the HART Communicator to the device and determine its device revision level. This information is most commonly accessed from Online menu>Device Setup>Detailed Setup>Device Information. For more information, see your device-specific manual.

SAVING A CONNECTED DEVICE CONFIGURATION

Selecting the **SAVE** option from any Online menu allows you to save a configuration transmitted from a connected device to a permanent storage location.

To save, change, and send a stored configuration:

1. Select **SAVE**.
2. Enter a storage location (Memory Module or data pack).
3. Enter a Name and configuration Data Type. Name defaults to the online device Tag, and the Data Type defaults to Standard with all editable variables marked.

NOTE: Saved configurations have to be “Full” for storing in your PC in AMS software.

Warnings appear if there is not enough memory to store the transmitted configuration or if there is no list of configurable variables with Data Type set to standard.

The **SAVE** key disappears until you change any configuration data.

4. To change the configuration data, go into the Device Setup menu options and change the required data. For example, if the Tag needs to be changed, start with the Device Setup menu and go into the Basic Setup menu options, open Tag, and change the data.

Press **ENTER** to load the changed data, then press **SEND** to send your changes to the connected device.

5. After each data configuration is sent, the **SAVE** function key appears. You have the option to save the individual variable or continue to change all of the variables and save them all at once.

- If you choose not to **SAVE** data but want to continue, the **SEND** key will reappear after each selection is entered.
- Repeat the above process where necessary to modify each device configuration.

When saving a new configuration or changing a saved configuration offline, you will not encounter the send key.

USING THE HOT KEY

The Hot Key menu is a user-definable menu that can hold up to 20 options of your most frequently performed tasks.

Figure 1-34 shows a typical Hot Key menu with four added options. The first option, Range values, is permanent and cannot be changed. It provides quick access to review or modify the device range values.

To use the Hot Key, you must properly connect the HART Communicator to a device. You can access the Hot Key menu from any menu, or before powering up the Communicator, by simply pressing the Hot Key.

To use the Hot Key menu:

- Connect the HART Communicator to a HART-compatible device.

- Press the Hot Key. 

- Initially, the Hot Key menu displays with only Range values listed. Refer to **Customizing the Hot Key Menu on page 1-31** for details on how to add options. The figure below shows some added options.

- Select the desired option from the Hot Key menu.

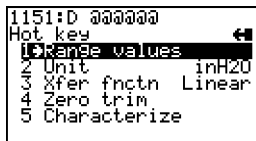

FIGURE 1-34. Sample Hot Key Menu.

- Follow the online instructions to perform the selected function.

NOTE: If your HART Communicator does not provide access to the Hot Key menu for a particular device, that device does not support Hot Key functionality.

Customizing the Hot Key Menu



You can customize the Hot Key menu to provide fast access to Range values and your most frequently used tasks. Range values is a permanent option providing quick access to rerange. This option cannot be deleted from the Hot Key menu.

Adding Options to the Hot Key Menu

The Hot Key menu has space for up to 20 online options. For example, if you have to change device tags and damping often, you can add these functions to the Hot Key menu. The HART Communicator automatically saves them so they can be quickly accessed by pressing the Hot Key. If you turn the unit off, then later turn it back on using the Hot Key, your customized menu will display.

With the Online menu or any of the submenu options open, use the following steps to add customized options to the Hot Key menu:

1. Using the up or down arrow key, move the menu bar to highlight the option you want to add to the Hot Key menu.
2. Press any one of the three shift keys, release it, and then press the Hot Key. This is shown in the following key sequence:



3. The Hotkey Configuration menu displays (**Figure 1-35**).

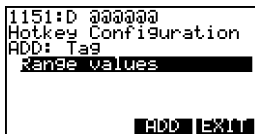

FIGURE 1-35. Hotkey Configuration Menu.

The Hotkey Configuration menu displays the new topic you want added to the current list of Hot Key options. The figure above indicates that Tag is being added to the Hot Key menu in addition to the permanent Range values feature. Press **ADD** (F3) to add the Tag option to the Hot Key menu. Press **EXIT** (F4) to exit the task and display the previous menu.

4. Press **ALL** (F1) to add the option to the Hot Key menu for all of the HART-compatible devices supported in your Communicator; or, press **ONE** (F4) to add the option to the Hot Key menu for the specific device to which you are currently connected. See **Figure 1-36**.

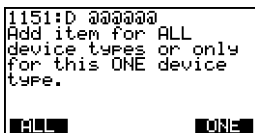

FIGURE 1-36. Adding a Hot Key Option.

5. If the message “Mark as read only variable on Hot Key menu?” **Figure 1-37** displays, press **YES** (F1) to mark the variable for this option as read-only, or press **NO** (F4) to mark the variable as read/write. For example, marking the tag number of a device to be read-only allows you to view, but not change, the tag number through the Hot Key menu.

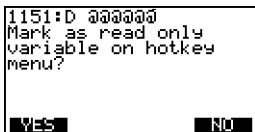

FIGURE 1-37. Marking a Read-Only Hot Key Option.

When adding a variable such as tag number, you can choose to display the current variable value as part of the menu option. If you choose to display the value of the variable in the Hot Key menu, the value appears next to the option. **Figure 1-38** shows the value of the tag displayed next to the tag option on the Hot Key menu.

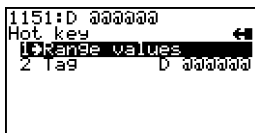

FIGURE 1-38. Hot Key Menu.

6. Press **YES** (F1) to display the variable associated with the option on the Hot Key menu, or press **NO** (F4) to not display it. See **Figure 1-39**.

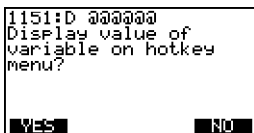

FIGURE 1-39. Variable Display Option.

7. Press **EXIT** (F4) on the Hot Key Configuration menu to complete the task. The options are now included on the Hot Key menu.

Deleting Options from the Hot Key Menu

Use the following steps to delete an online option from the Hot Key menu:

1. Press any one of the three shift keys, release it, and then press the Hot Key. This is shown in the following key sequence:



2. The Hotkey Configuration menu is displayed (**Figure 1-40**).



FIGURE 1-40. Deleting a Hot Key Option.

Move the menu bar to highlight the option to be deleted and press **DEL** (F2). The menu bar will move to the next menu option. Press **DEL** (F2) to delete the next highlighted option, as desired. The Range values functionality cannot be deleted.

3. When you are through deleting options, press **EXIT** (F4) to exit the Hotkey Configuration menu and return to the menu containing the option you just deleted.

Note: For an easy method to quickly delete all menu items added to the Hot Key menu, refer to Delete Configs Menu on page 1-25.

THE HART COMMUNICATOR AND THE YEAR 2000

The HART Communicator is Year 2000 Compliant if the operating system is level 4.6 or greater. To determine the operating system level in your HART Communicator, turn it on. The first screen displays the "Module Rev", which is the operating system level. If you need to update your operating system software, contact your nearest product representative.

NOTE: When you power up the Communicator, the Firmware Rev number appears first. A few seconds later, the Module Rev number displays one line below the Firmware Rev.

Editing the Date

When you edit a date, you have three fields to edit: the first field is the month, the second field is the day, and the third field is the year.

If you enter the year using two digits, the HART Communicator will assume that the year is 1900 plus the value you enter.

If you enter four digits, the HART Communicator will use all four digits to represent the year. By definition in the HART PROTOCOL, the year must be between 1900 and 2155.

When a date is displayed, the HART Communicator will display two digits in the year if the year is between 1900 and 1999. If the year is 2000 or greater, the HART Communicator will display all four digits.



FIGURE 1-41. Date Menu.

SERVICING THE HART COMMUNICATOR

As shown in **Figure 1-42**, the modular construction of the HART Communicator allows easy disassembly of the battery pack, the Memory Module, and the data pack 100. This section discusses how to change alkaline batteries, recharge the NiCad battery pack, upgrade the Communicator software, and install and remove the data pack 100.

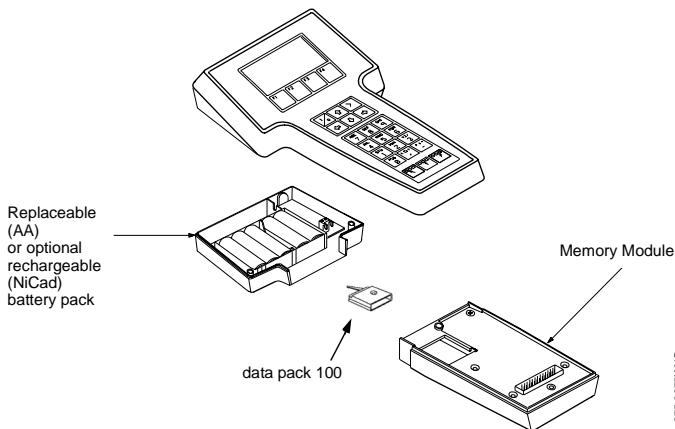

FIGURE 1-42. HART Communicator Exploded View.

Calibrating the HART Communicator

It is not necessary or possible to calibrate your HART Communicator. It has no measurement circuitry and does not measure analog output from the field device. The Communicator is strictly a communication interface that communicates digitally with HART-compatible devices. It is not applicable to NIST standards, and is not subject to calibration.

Using a Battery Pack

The HART Communicator is available with a battery pack that holds five AA alkaline cells, or with a rechargeable nickel-cadmium power pack. The alkaline cells last approximately 150 hours, and the NiCad cells last approximately 60 hours with normal usage. When approximately one hour of battery life remains, a low-battery icon appears in the upper right corner of the display.

Changing Alkaline Batteries

WARNING

Explosions can result in death or serious injury. Do not remove or replace battery pack in an explosive atmosphere.

Refer to **Figure 1-43** and use the following steps to change alkaline batteries:



FIGURE 1-43. Battery Pack Removal.

1. Completely loosen the three captive screws holding the Communicator battery pack.
2. Grasp the battery pack and pull it away from the Communicator. Make sure not to bend the pins connecting the battery pack to the Communicator.
3. Remove and properly dispose of batteries.
4. Referring to the battery orientation diagram inside the battery pack, insert five new AA alkaline batteries.
5. Carefully align the pins with the Communicator base and replace the battery pack.
6. Tighten the three screws.
7. Turn on the Communicator to verify operation and ensure the batteries are installed properly.

Recharging the Battery Pack



Explosions can result in death or serious injury. Do not recharge the NiCad battery pack in an explosive atmosphere.

NiCad battery packs are shipped from the factory discharged. Prior to the first use, charge the battery pack while it is disconnected from the Communicator. Subsequent charges may be performed while using or storing the HART Communicator, without removing the battery pack.

NOTE: If the HART Communicator is stored for an extended period of time, or the battery pack becomes completely discharged, remove the battery pack from the Communicator and recharge it separately prior to using.

To recharge while using the Communicator, plug the recharger into an AC outlet or power source. To recharge while storing the Communicator, plug the recharger into an AC outlet or power source, make sure the HART Communicator is off, and charge for 16 hours. Overcharging will not harm the Communicator battery pack.

NOTE: For optimum performance, periodically discharge (use battery power until the low battery icon appears) and then fully recharge the battery pack.

Using a Memory Module

The HART Communicator is supplied with a replaceable Memory Module (**Figure 1-44**). A 12 MB Memory Module is the recommended standard.

The Memory Module is programmed to communicate with specific HART-compatible devices. Refer to **Reviewing Installed Devices on page 1-12** to find the specific HART-compatible devices that are programmed into your Communicator's Memory Module.

If you find that some specific devices are not listed in your Memory Module, contact your nearest service representative. Your Memory Module may be reprogrammed or replaced to include support for the required HART devices.

Replacing the Memory Module

WARNING

Explosions can result in death or serious injury. Do not remove or replace battery pack in an explosive atmosphere.

Refer to **Figure 1-43** and **Figure 1-44**, and use the following steps to replace the Memory Module:



FIGURE 1-44. Memory Module Replacement.

1. Completely loosen the three captive screws holding the Communicator battery pack.
2. Grasp the battery pack and pull it straight up from the Communicator. Do not bend the battery pack's connecting pins during the process.
3. Loosen the two captive screws holding the Memory Module.
4. Grasp the Memory Module and pull it away from the Communicator.
5. Align the new Memory Module with the Communicator, tighten the two screws, and replace the battery pack.

Installing and Removing the Data Pack 100

Refer to **Figure 1-43**, **Figure 1-44**, and **Figure 1-45**.

Use the following steps to install or remove the data pack:



FIGURE 1-45. Data Pack 100 Installation and Removal.

To Install the data pack:

1. Remove the battery pack from the Communicator. Next, either remove the Memory Module or leave it assembled to the Communicator.
2. The data pack is keyed to prevent incorrect installation. When the Communicator is facing down, insert the data pack with the part number label facing down; the hinge of the handle will be on the left. Press firmly in place with your fingers.

To remove the data pack:

1. Insert the flat edge of a small screwdriver under the outside edge of the handle. Lift the handle to disconnect the data pack from its connector.
2. Raise the handle and pull the data pack out of the Memory Module.

SECTION 2

Common Tasks for Fisher-Rosemount HART Devices

INTRODUCTION

This section displays HART Communicator menus and describes tasks common to Fisher-Rosemount HART products.

POWERING UP ONLINE

Powering up online provides direct access to the Online menu. This menu provides critical data that is continuously updated. To be powered online, the Communicator must be connected to a 4–20 mA loop.

To power up the Communicator and access a HART compatible device:

1. Be sure the Communicator is connected to a HART compatible device.
See **HART Communicator Connections on page 1-2** for information about proper connections.
2. Power the Communicator by pressing the On/Off key. 

NOTE: If a device is found, the HART Communicator displays the Online menu. If no device is found, the Communicator displays the Main menu. If no device is found, check the connections, verify the presence of the 250 ohms load resistance in series in the loop, and retry by selecting 'Online.' To poll multiple devices in the loop, refer to **Polling Menu on page 1-23**. For help on communication problems, see **Appendix D**.



ONLINE MENU

The Online menu is the first menu to appear when the Communicator is connected to a HART compatible device. This menu is structured to provide important information about the connected device immediately on powering up the Communicator (**Figure 2-1**). This menu displays critical, up-to-date device information including primary variable, analog output, lower range value, and upper range value.



FIGURE 2-1. Online Menu.

Because of the important information provided in the Online menu, some other menus provide instant access to it. When access is available, the **HOME** label appears above the F3 key. Press **HOME** (F3) to return to the Online menu. For more information about the Home key, refer to **Section 1**.

Move through the menu using  and  and press  to select an option, or simply press the corresponding numerical key. The Online menu options are described as follows.

Device Setup

Press  to access the Device Setup menu from the Online menu.

The Device Setup menu accesses every configurable parameter of the connected device. Refer to the **Device Setup Menu on page 2-4** for more information.

Primary Variable (PV)

Press

VWX
2

 to access Primary Variable.

The Online menu displays critical process information that is continuously updated. If the PV and related engineering units are too long, they will not appear on the Online menu. Select PV to view primary variable and the related engineering units.

Analog Output (AO)

Press

YZ /
3

 to access Analog Output.

The analog output is the signal on the 4–20 mA scale that corresponds to the primary variable. When the AO contains too many characters to display on the Online menu, select AO to view the analog output and related engineering units.

Lower Range Value (LRV)

Press

JKL
4

 to access Lower Range Value.

Select LRV to view the lower range value and related engineering units.

Upper Range Value (URV)

Press

MNO
5

 to access Upper Range Value.

Select URV to view the upper range value and related engineering units.

DEVICE SETUP MENU

As shown in **Figure 2-2**, the Device Setup menu contains the following five options:

Press **STU 1** to access the Device Setup menu from the Online menu. The options on this menu (**Figure 2-2**) are described in the following paragraphs.

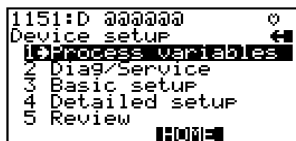

FIGURE 2-2. Device Setup Menu.

Process Variables

Press **STU 1** to access the Process Variables menu.

This menu lists all process variables and their values. These process variables are continuously updated.

Diag/Service

Press **VWX 2** to access the Diag/Service menu.

This menu offers device and loop tests as well as calibration options. **Figure 2-3** illustrates a typical menu.



FIGURE 2-3. Diagnostics and Service Menu.

Test device initiates a diagnostic routine at the device and can report an electronics failure, as well as other failures that can affect performance.

Loop test can fix the transmitter output at a specified analog value, and can be used to test the integrity of the loop and the operation of indicators, recorders, or similar devices in the loop.

Calibration can include such operations as configuring output related parameters, performing a sensor trim, or performing an analog output trim.

Basic Setup

Press  to access the Basic Setup menu.

This menu provides quick access to a number of configurable parameters including tag, unit, range values, and damping. **Figure 2-4** illustrates a typical Basic setup menu.



FIGURE 2-4. Basic Setup Menu.

The tag number identifies a specific device. Changing units affects the engineering units that are displayed. Reranging changes the analog output scaling. Changing damping affects the response time of the transmitter to smooth the output when there are rapid input variations.

The options available in the Basic Setup menu are the most fundamental tasks that can be simply performed with a given device. These tasks are a subset of the options available under the Detailed Setup menu.

Detailed Setup

Press  to access the Detailed setup menu.

This menu provides access to every editable device parameter and all device functions. The Detailed Setup menu varies widely from one HART compatible device to another. Functions in this menu can include tasks such as characterization, configuration, and sensor and output trims.

Review

Press

MNO
5

 to access the Review menu.

This menu lists all of the parameters stored in the connected device, including information about the measuring element, signal condition, and output. It also includes stored information about the connected device such as tag, materials of construction, and device software revision.

FAST KEY SEQUENCES

A fast key sequence is simply a sequence of numerical button presses, corresponding to the menu options that lead you to a given task. For example, **Figure 2-5** displays the fast key sequence for trimming analog output on a Model 1151 Pressure Transmitter.

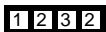

FIGURE 2-5. Sample Fast Key Sequence.

The first digit represents option number one on the Online menu. Once this option is selected, the Device Setup menu appears. The second digit represents option number two of the Device Setup menu, which is the Diagnostics and Service menu. The Calibration menu is activated by pressing the third digit, and the fourth digit accesses the trim analog output option of the Calibration menu. This example is illustrated for the Model 1151 Pressure Transmitter on **page 2-7**. For more detailed information on fast key sequences, consult your product manual.

Trimming the analog output is a calibration of the output circuitry, by setting the 4 and 20 mA points. Once the 4 and 20 mA points are set, all intermediate values are automatically adjusted. See **Menu Trees in Section 3** for a corresponding menu tree.

```
1151:D 000000
Online
1 Device setup
2 PV 50.0000 inH2O
3 AO 12.000 mA
4 LRV 0.0000 inH2O
5 URV 100.0000 inH2O
```

From the Online menu, select Device setup.

```
1151:D 000000
Device setup
1 Process variables
2 Diag/Service
3 Basic setup
4 Detailed setup
5 Review
HOME
```

From the Device setup menu, select Diag/Service.

```
1151:D 000000
Diag/Service
1 Test device
2 Loop test
3 Calibration
HOME
```

From the Diag/Service menu, select Calibration.

```
1151:D 000000
Calibration
1 Re-range
2 Trim analog output
3 Sensor trim
HOME
```

From the Calibration menu, select Trim analog output.

```
1151:D 000000
Trim analog output
1 D/A trim
2 Scaled D/A trim
HELP HOME
```

From the Trim Analog Output menu, select the desired option and follow the on-line instructions.

SECTION 3

Menu Trees

INTRODUCTION

This section displays typical examples of menu trees for specific Fisher-Rosemount products.

Menu trees show the primary commands and options available when using a sequence of menu selections. Text displayed in all bold capital letters in the menu trees indicates a progression to the next level. Due to space limitations, all levels may not be shown. Also note that your specific device could be different from the example shown. Consult your product manual for more detailed information.

The menu trees are identified by product and model number at the top of the page and are arranged in numeric-alpha order.



Model 54pH/ORP Transmitter

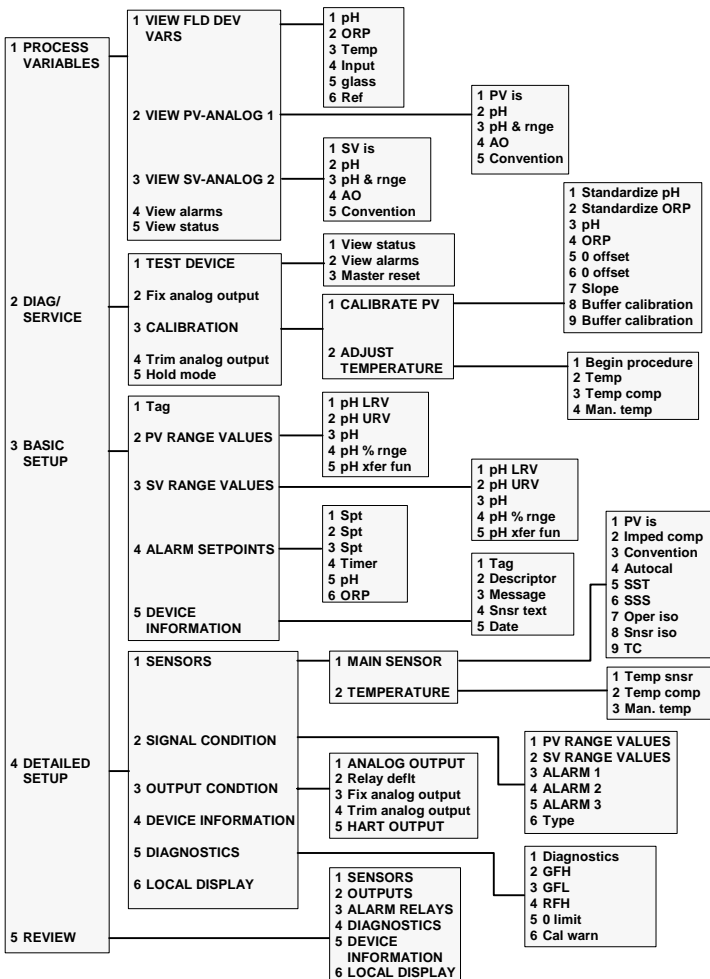



Model 333 HART® Tri-Loop Converter

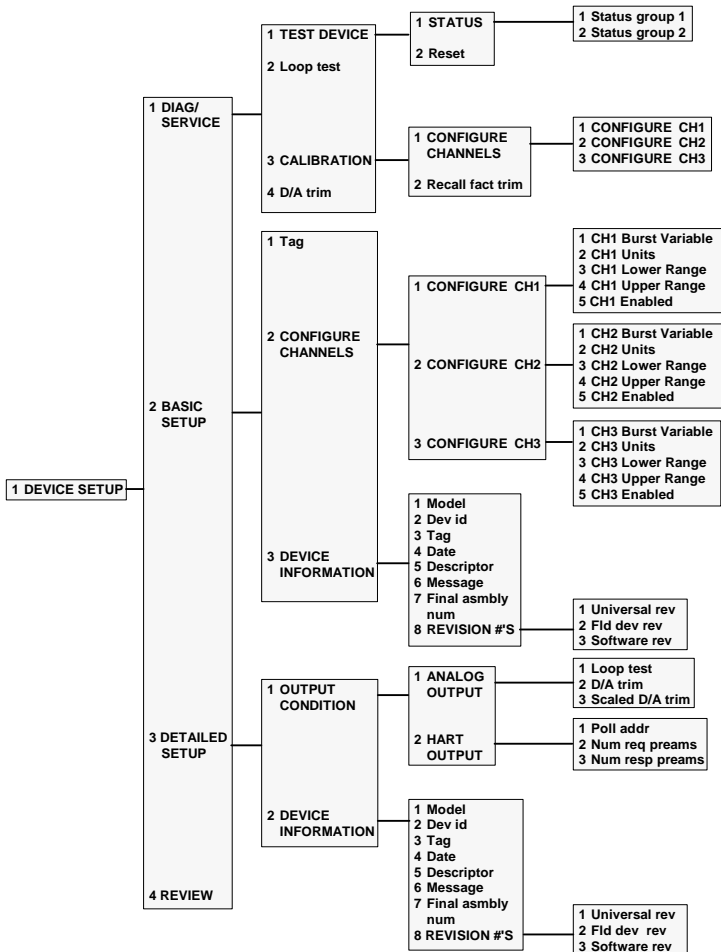



Model 644 Temperature Transmitter

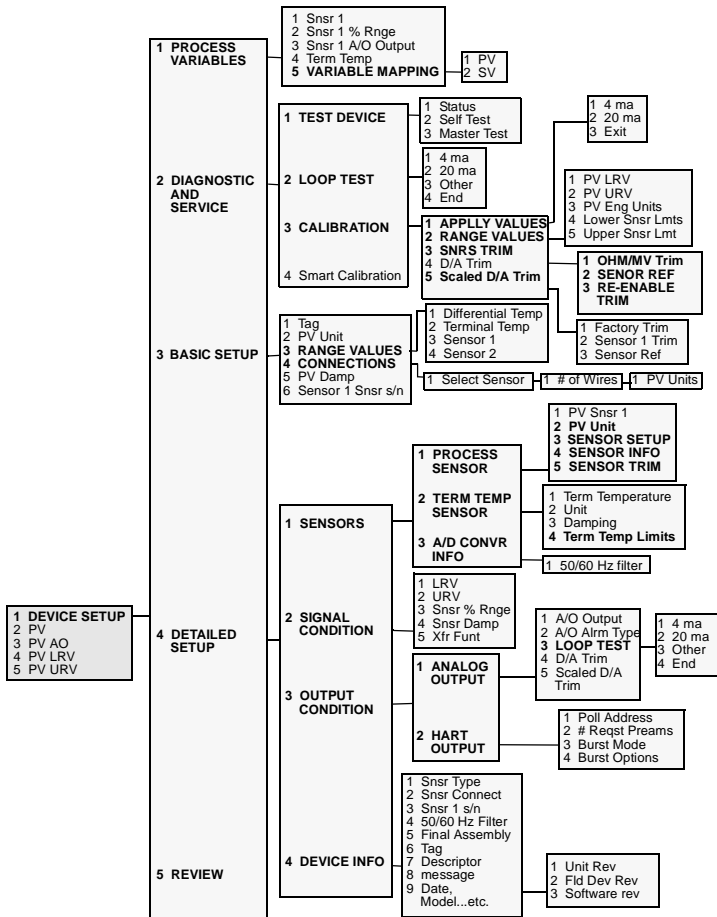

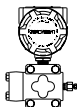

Model 1151 Pressure Transmitter

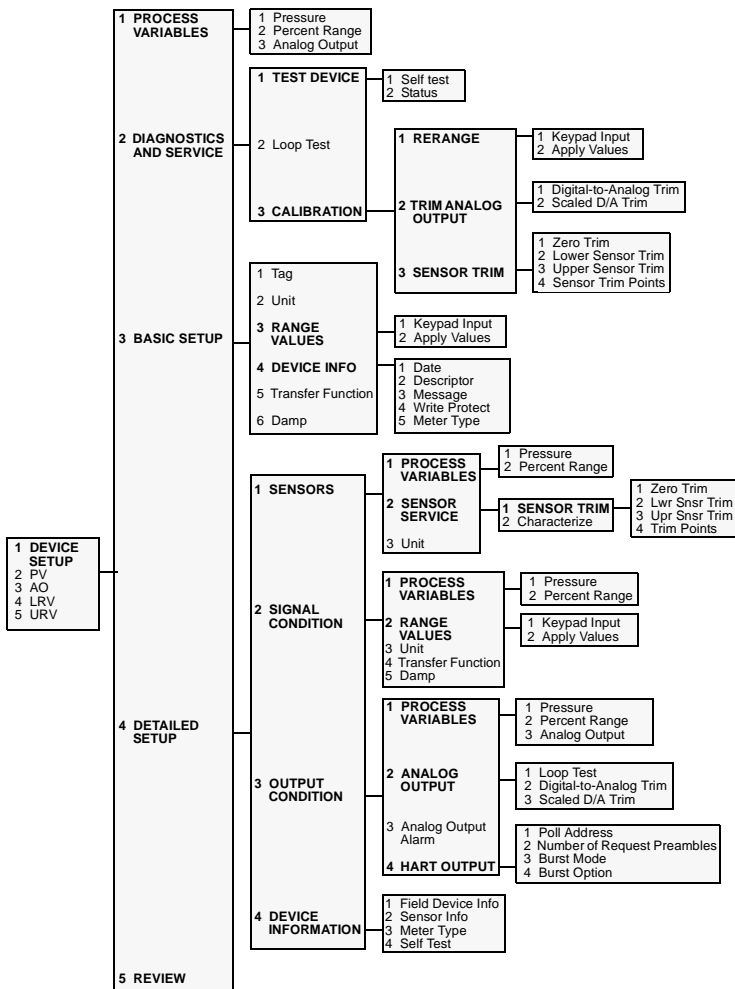



Model 2081C Conductivity Transmitter

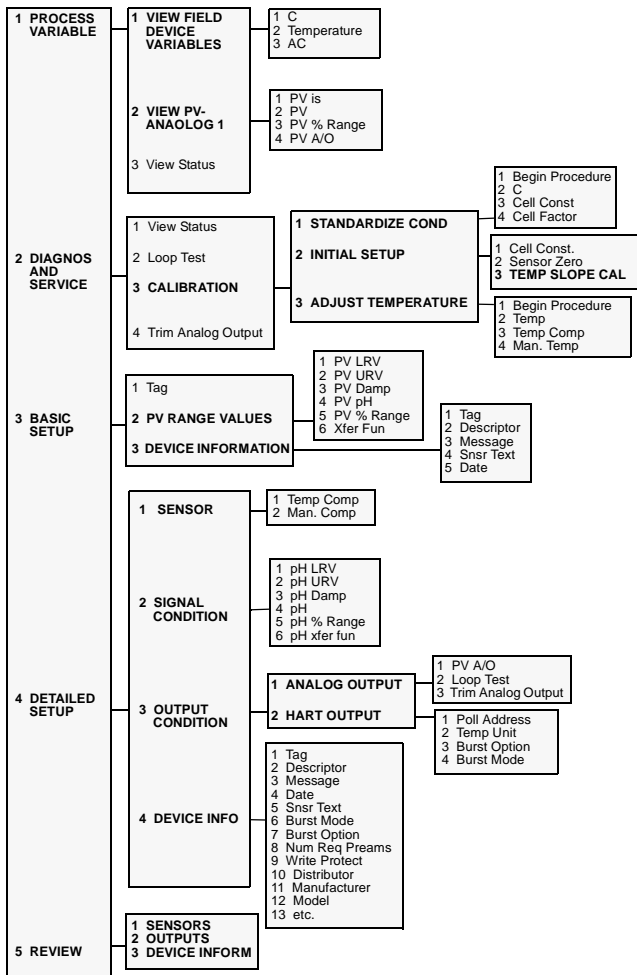



Model 2081pH Transmitter

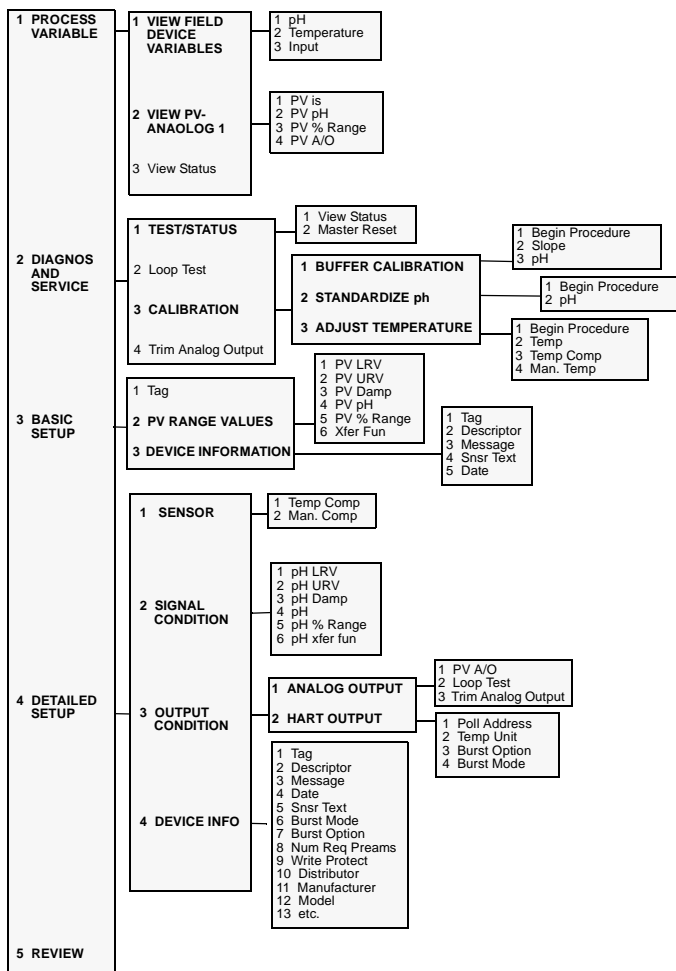



Model 2088 Pressure Transmitter

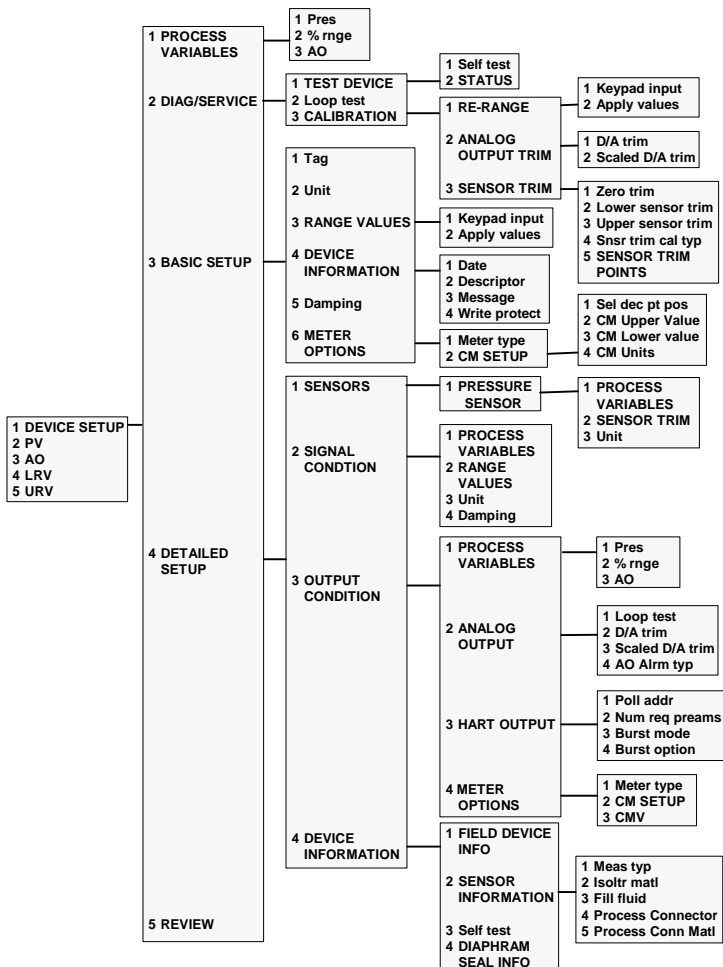



Model 2090 Pressure Transmitter

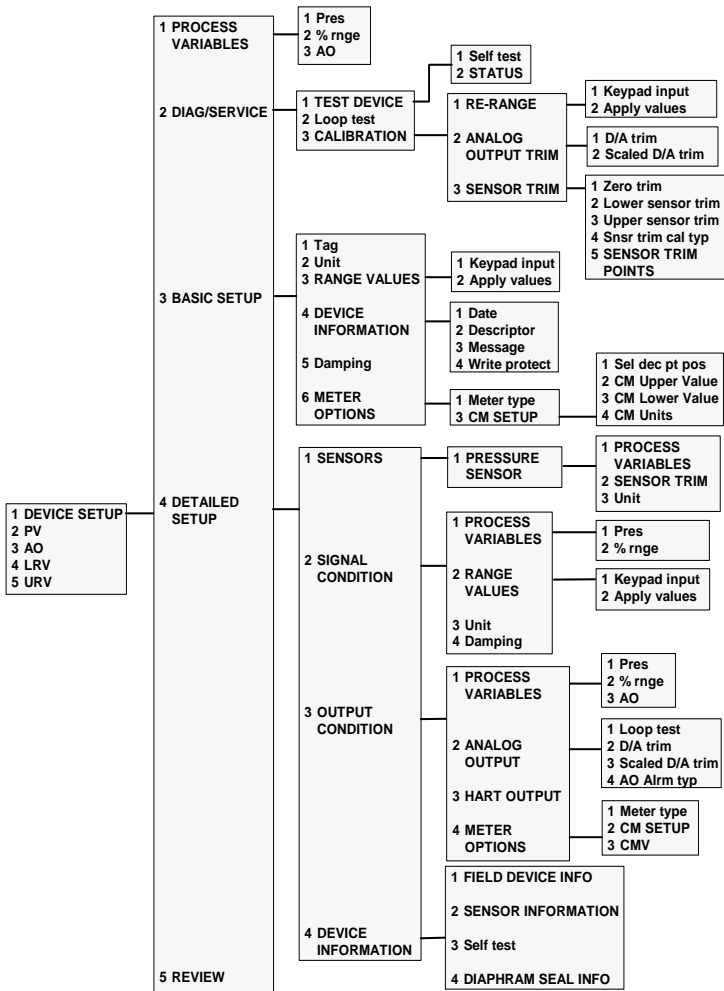



Model 3001S Hydrostatic Transmitter

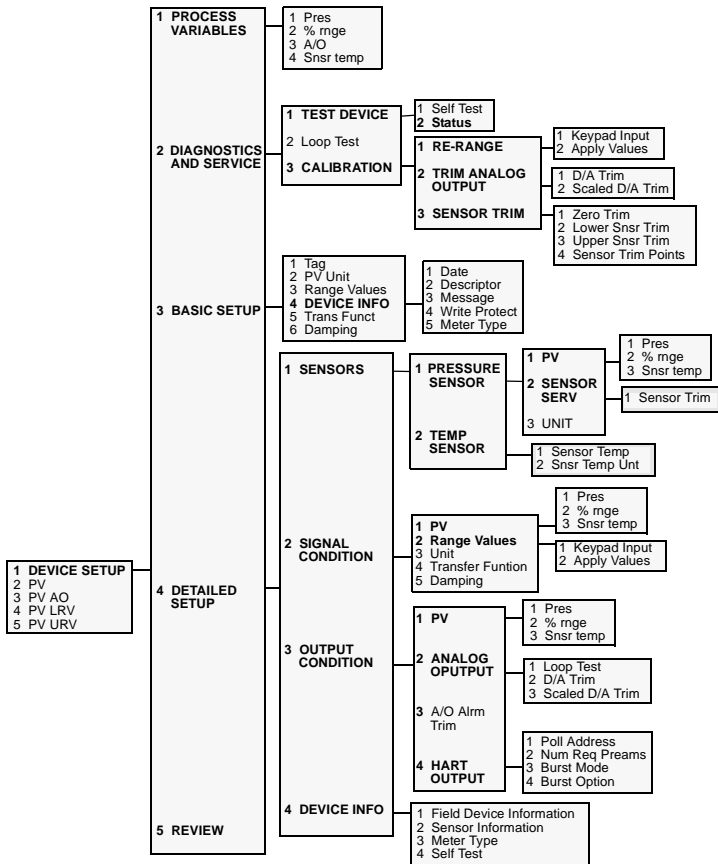



Model 3044C Temperature Transmitter

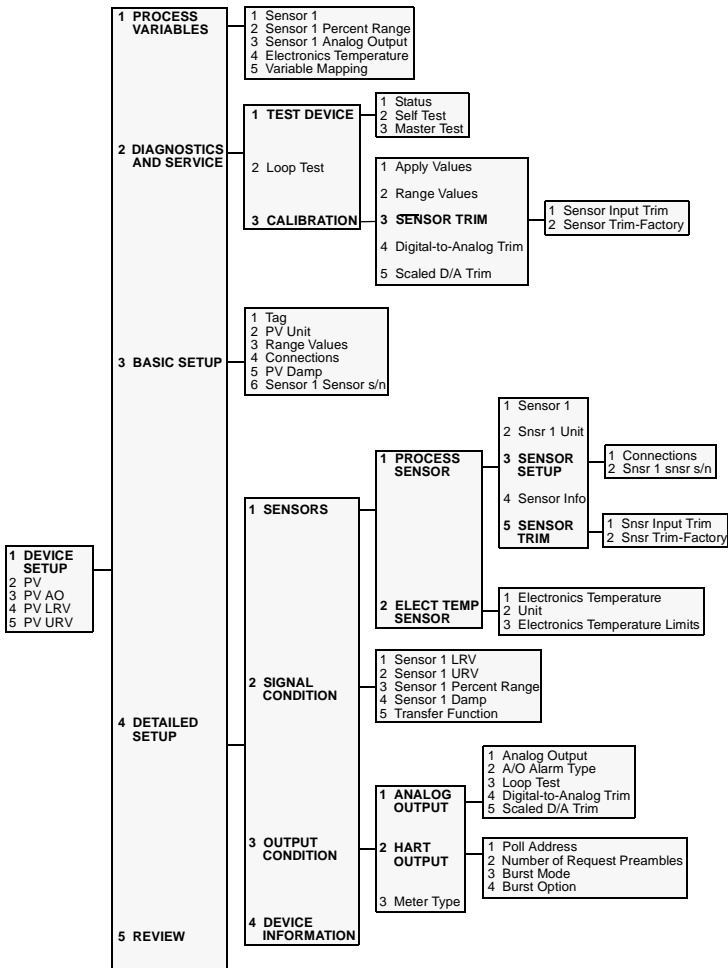



Model 3051 Pressure Transmitter

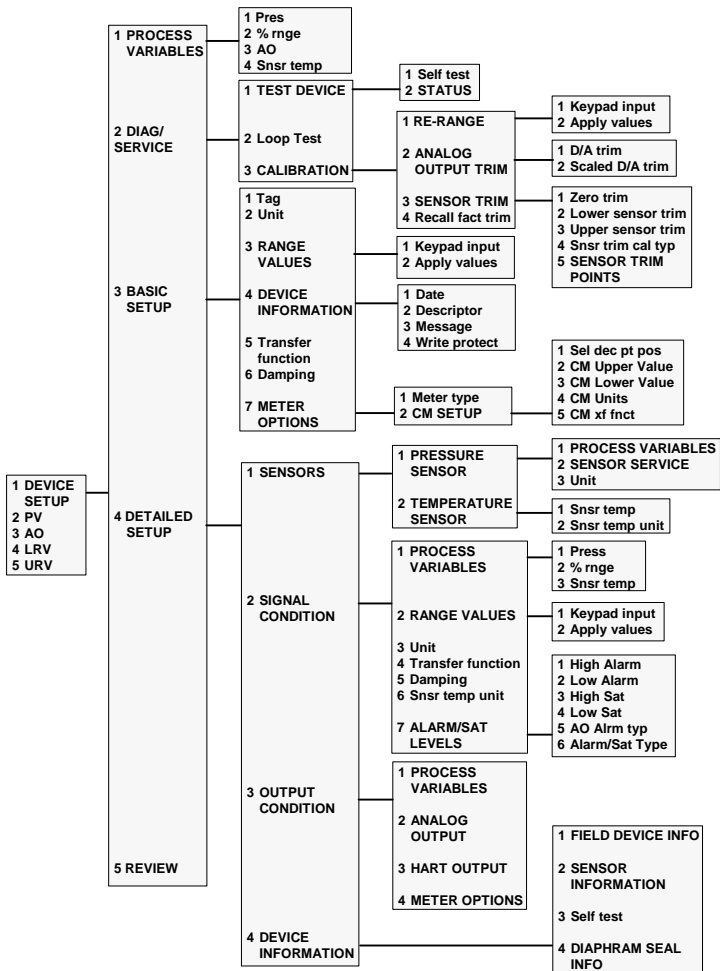



Model 3051C Pressure Transmitter (Original)

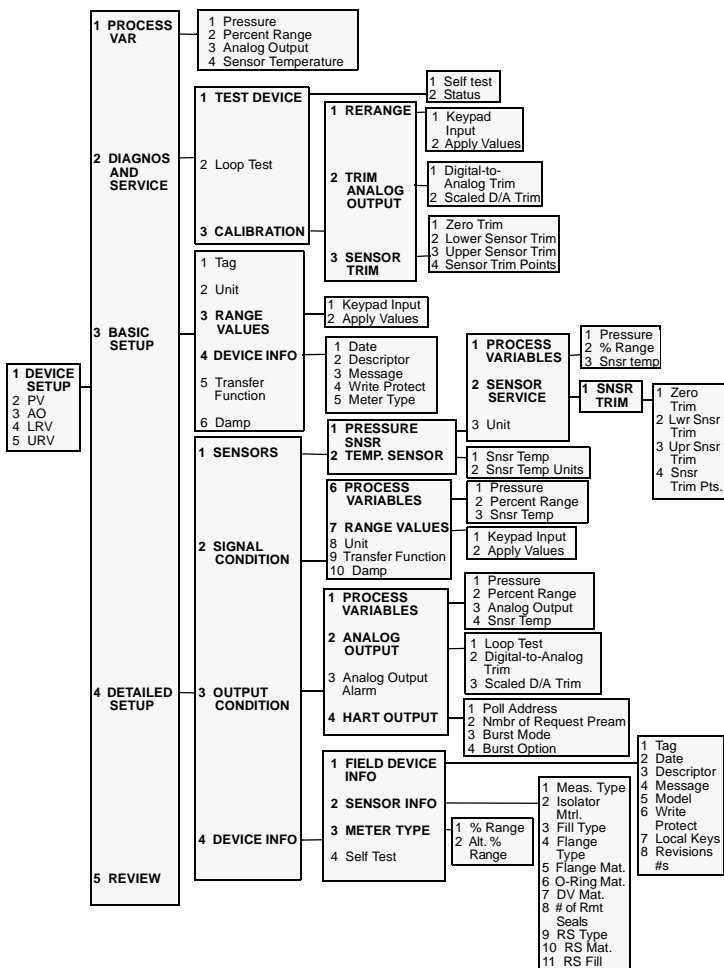



Model 3081C Conductivity Transmitter

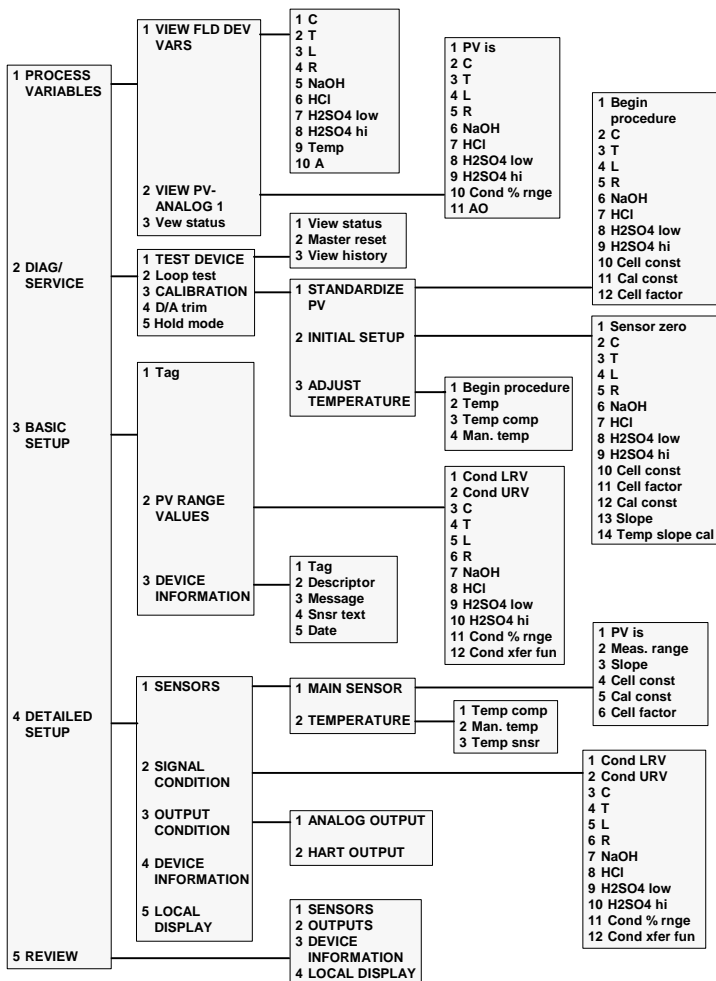

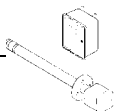

Model 3081FG Oxygen Analyzer

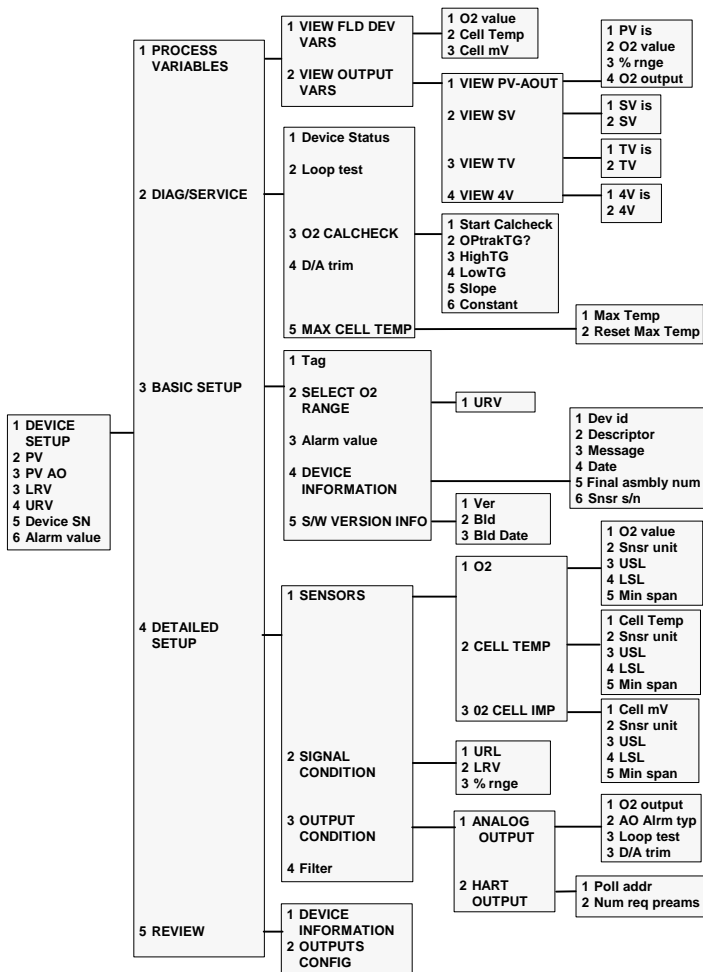



Model 3081pH Transmitter

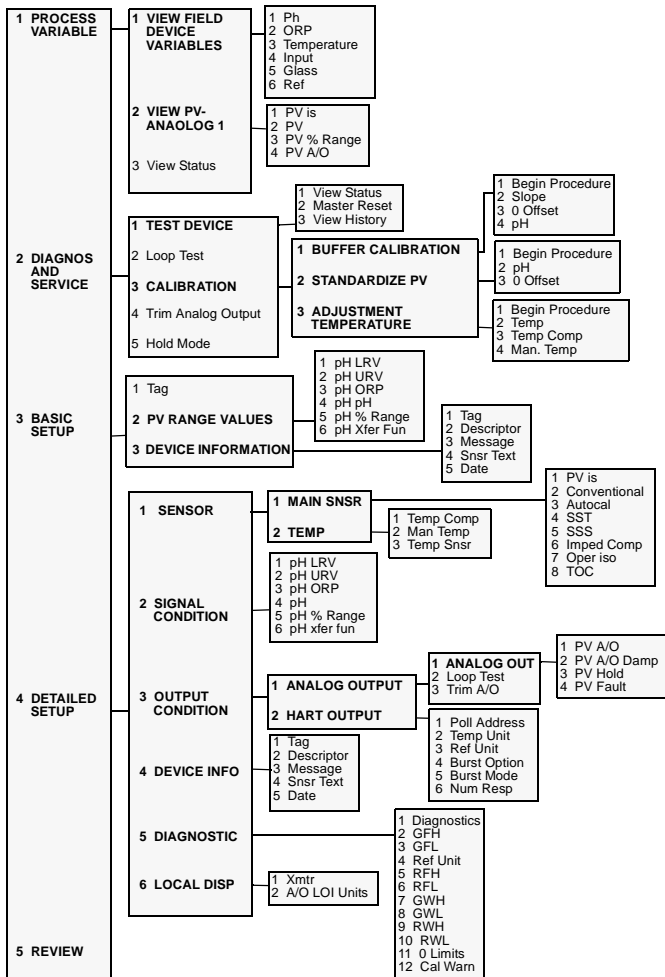



Model 3095C Level Controller

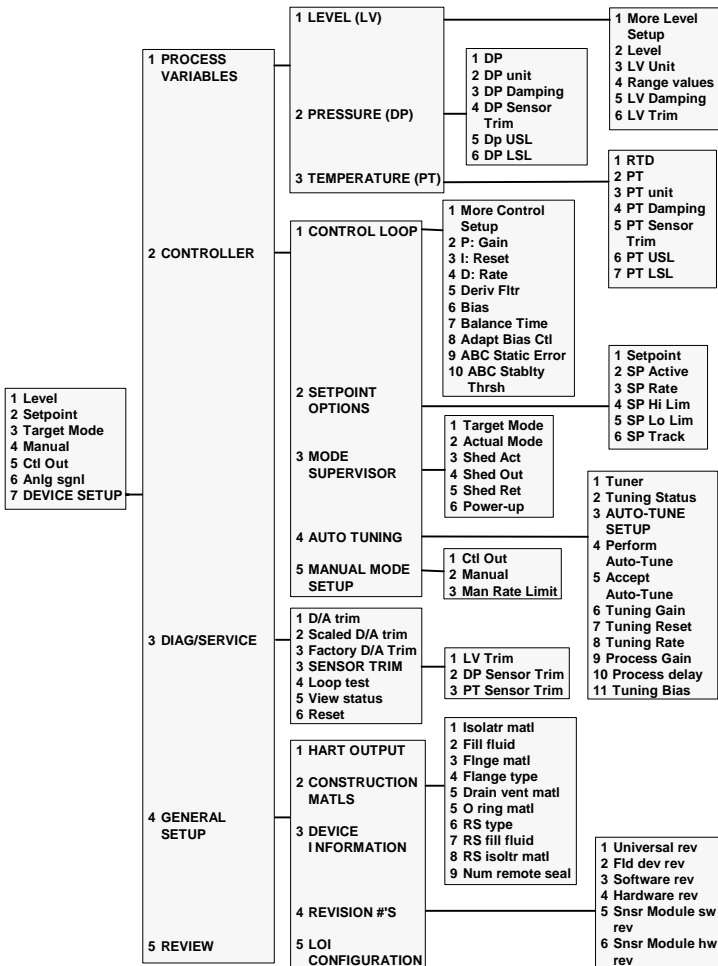



Model 3095MV Multivariable Transmitter

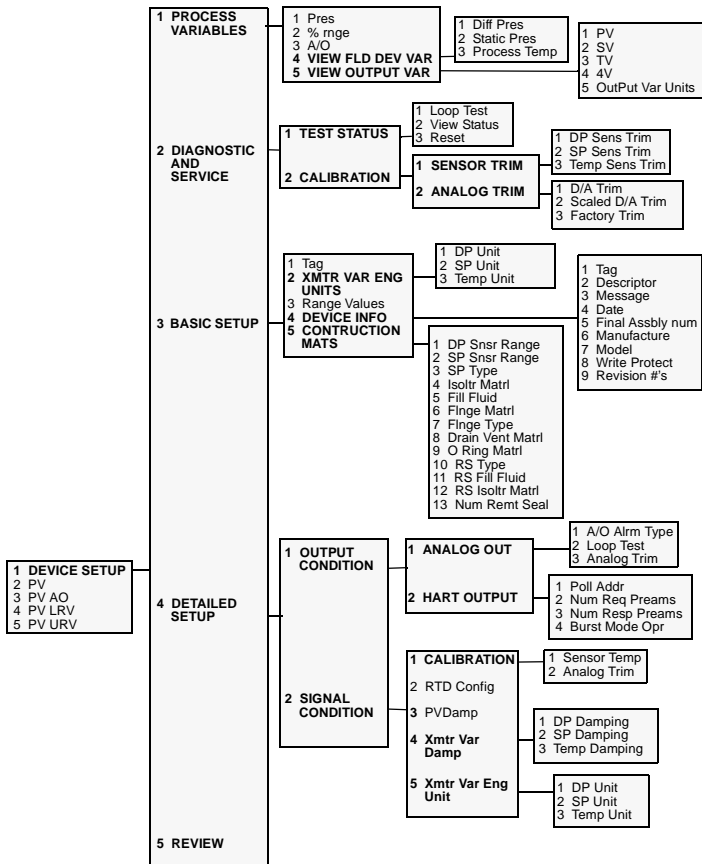



Model 3144 Temperature Transmitter

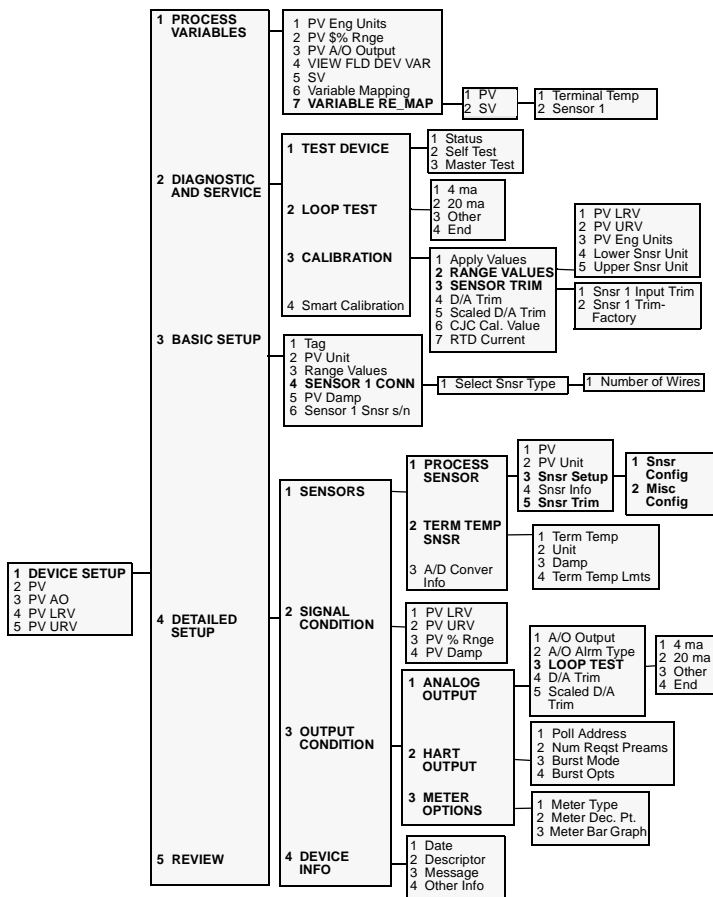



Model 3201 Hydrostatic Interface Unit

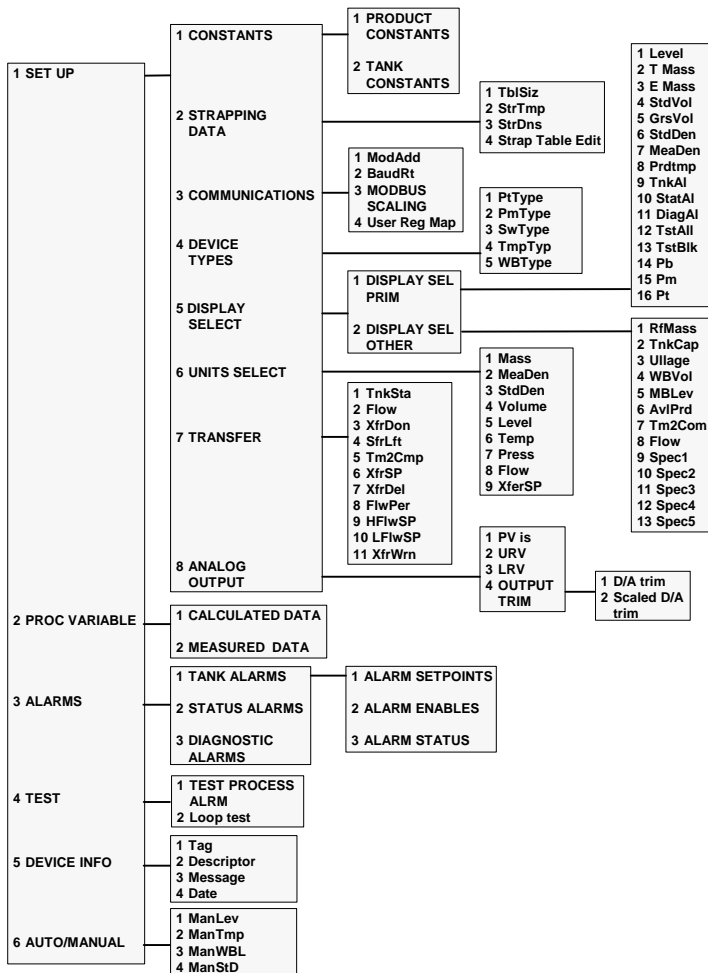



Model 3202 Smart Application Module

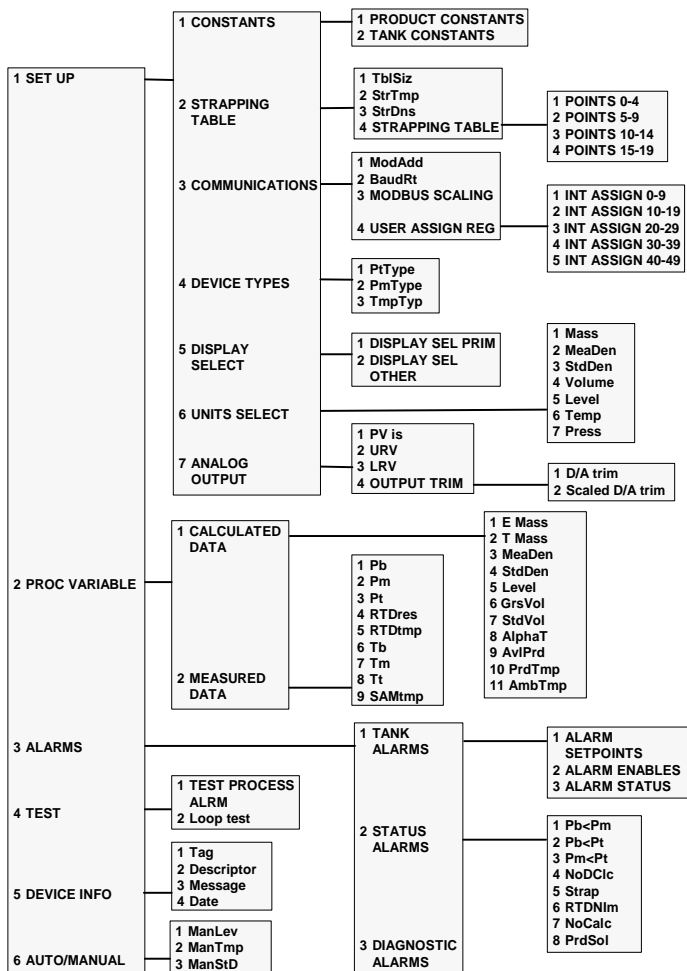



Model 3244 Temperature Transmitter

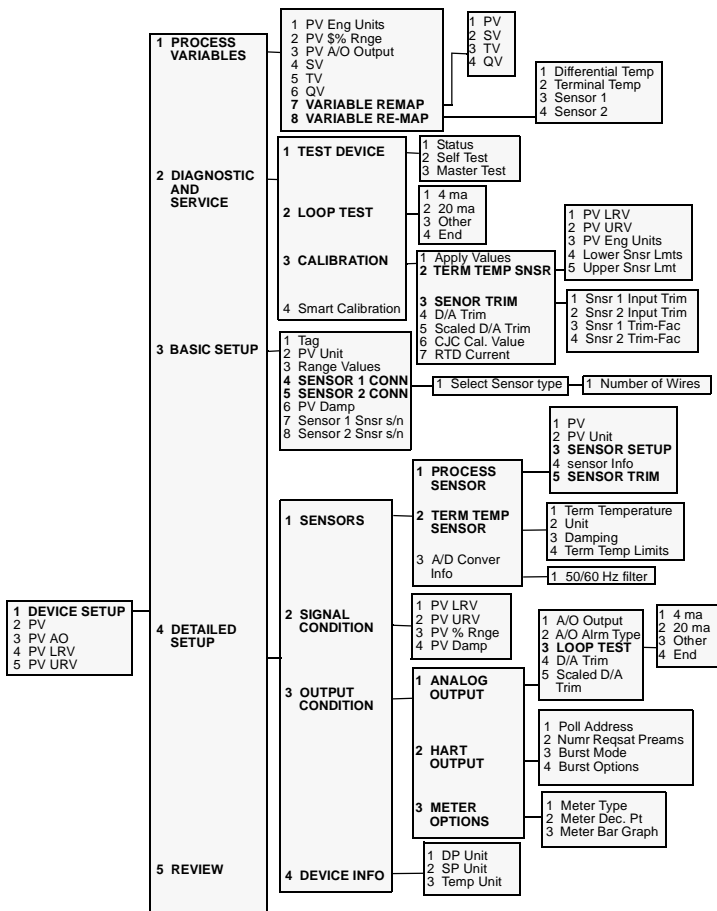



Model 3680 Density Transmitter

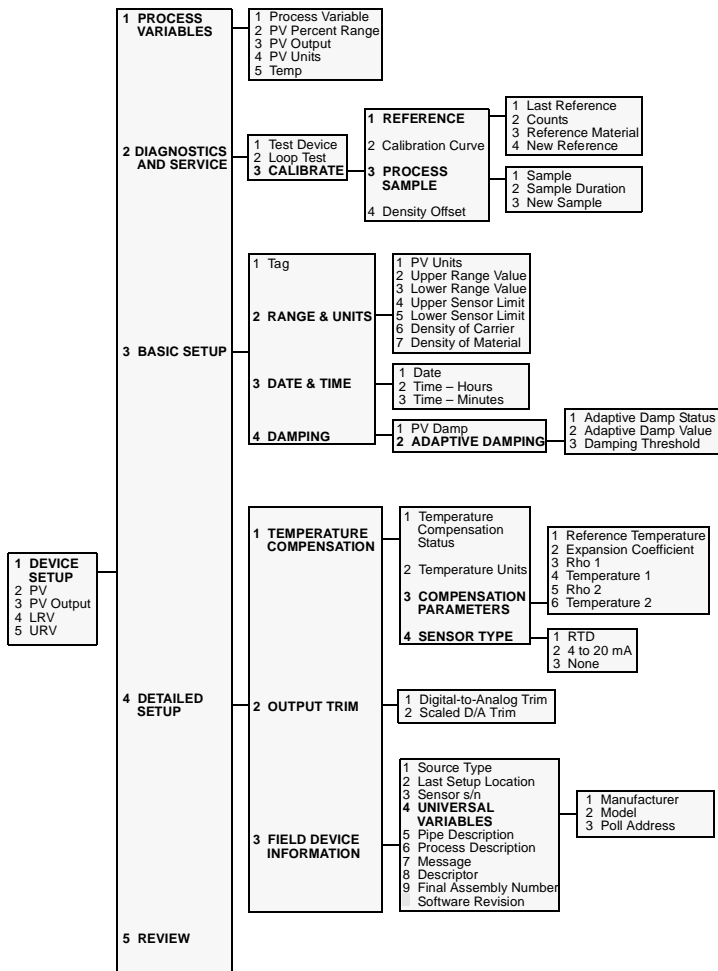



Model 3809/3810 Variable Area Meter

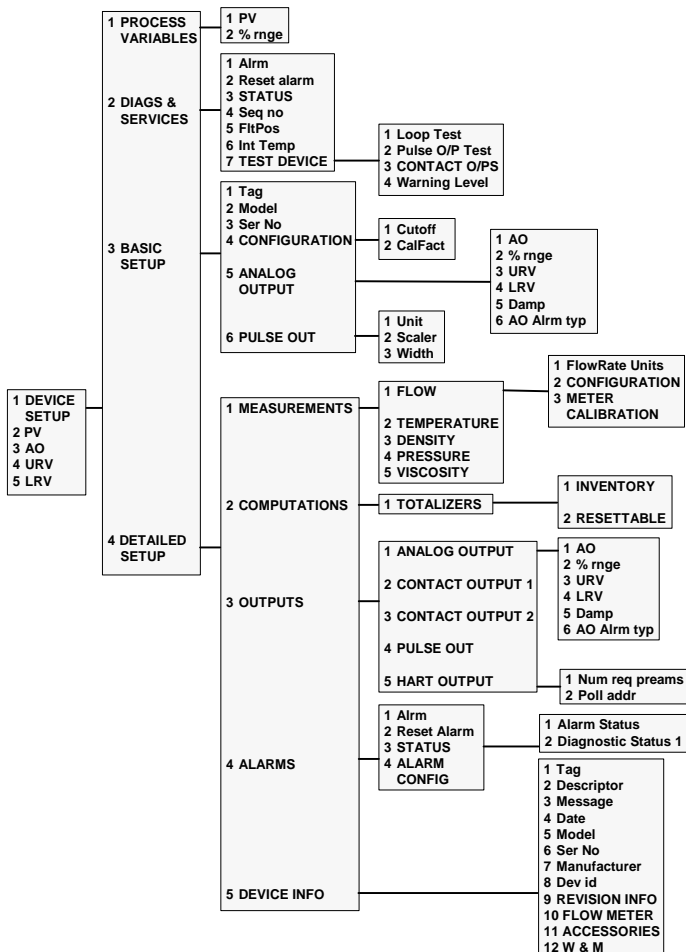

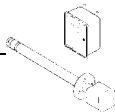

Model 4000 Oxygen Analyzer

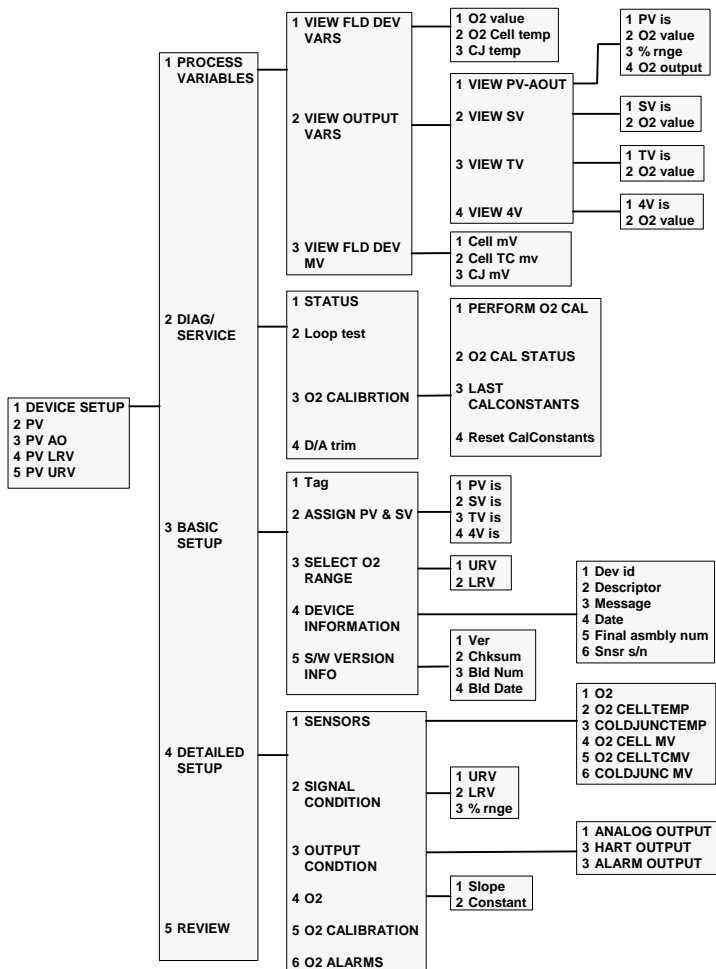



Model 8712C Mag Flow Transmitter

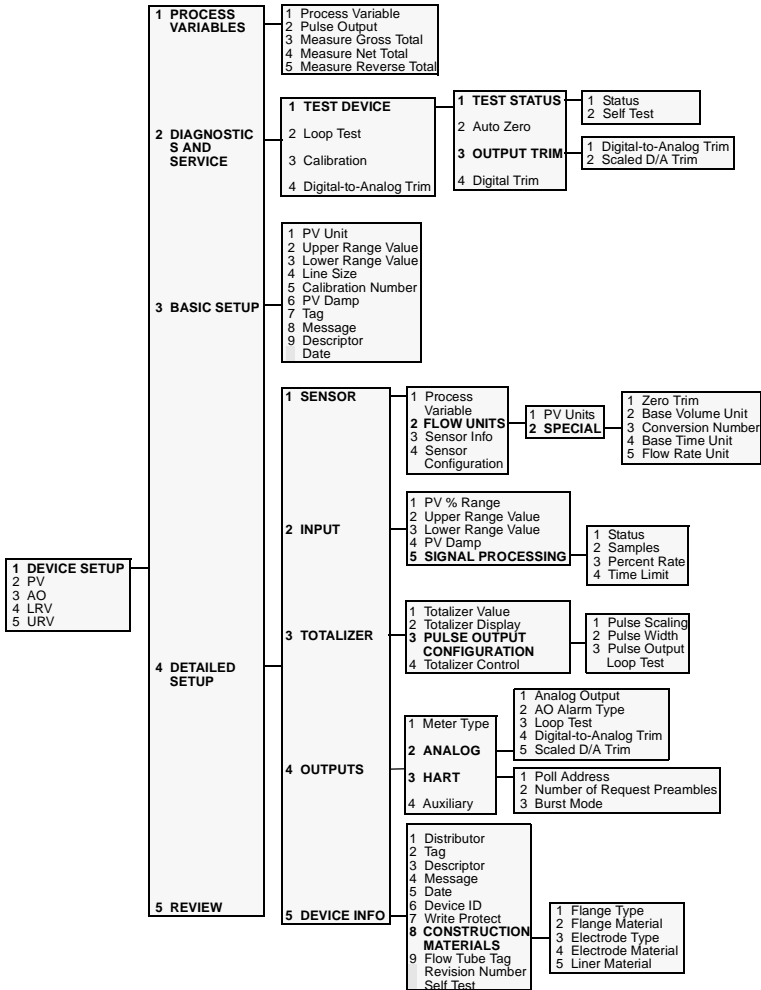



Model 8712C+ Mag Flow Transmitter

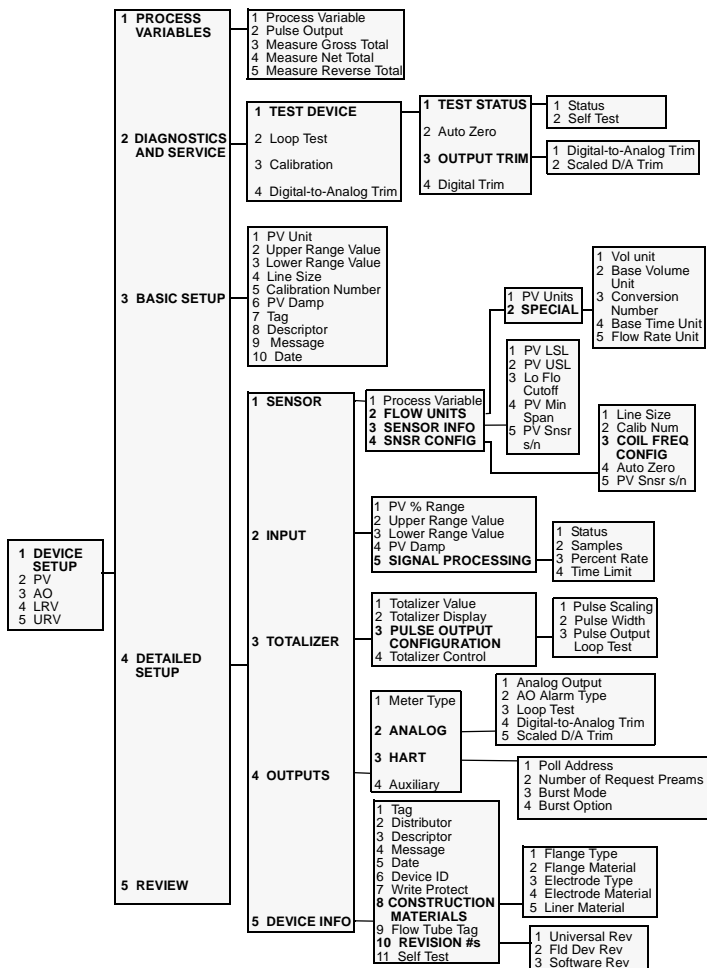



Model 8712U+ Mag Flow Transmitter

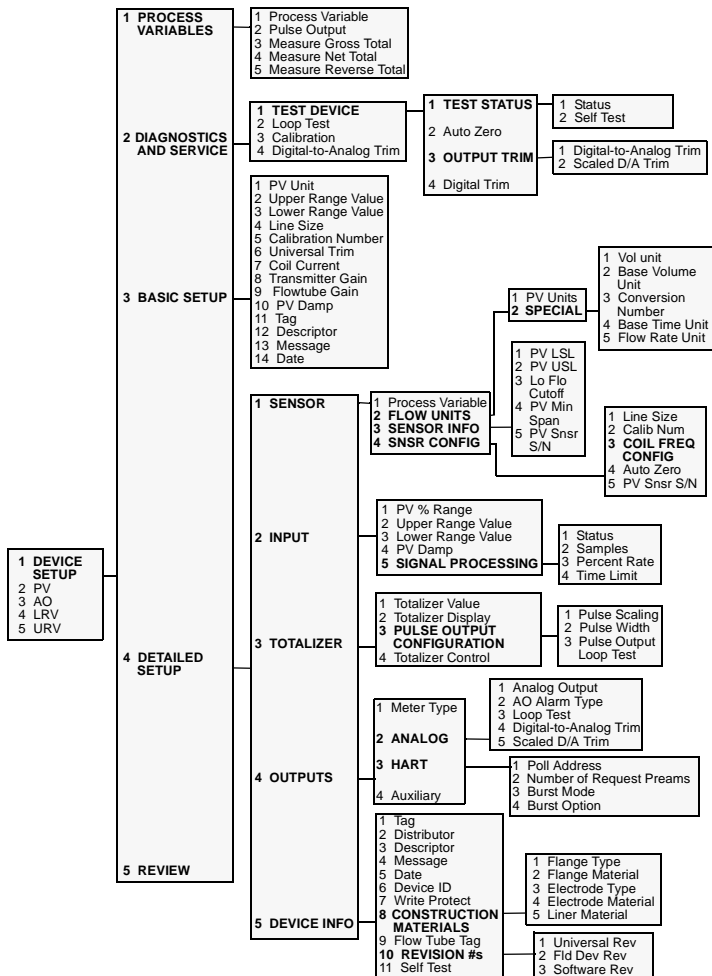



Model 8800 Vortex Flowmeter

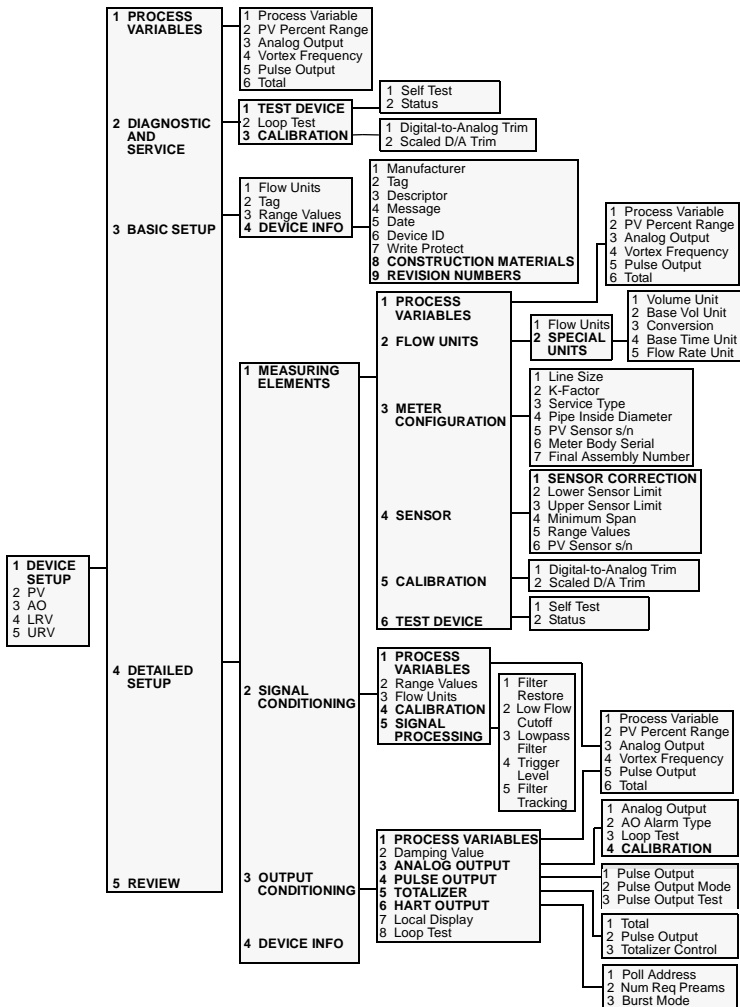

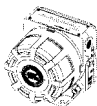

Model 9701 Mass Flowmeter

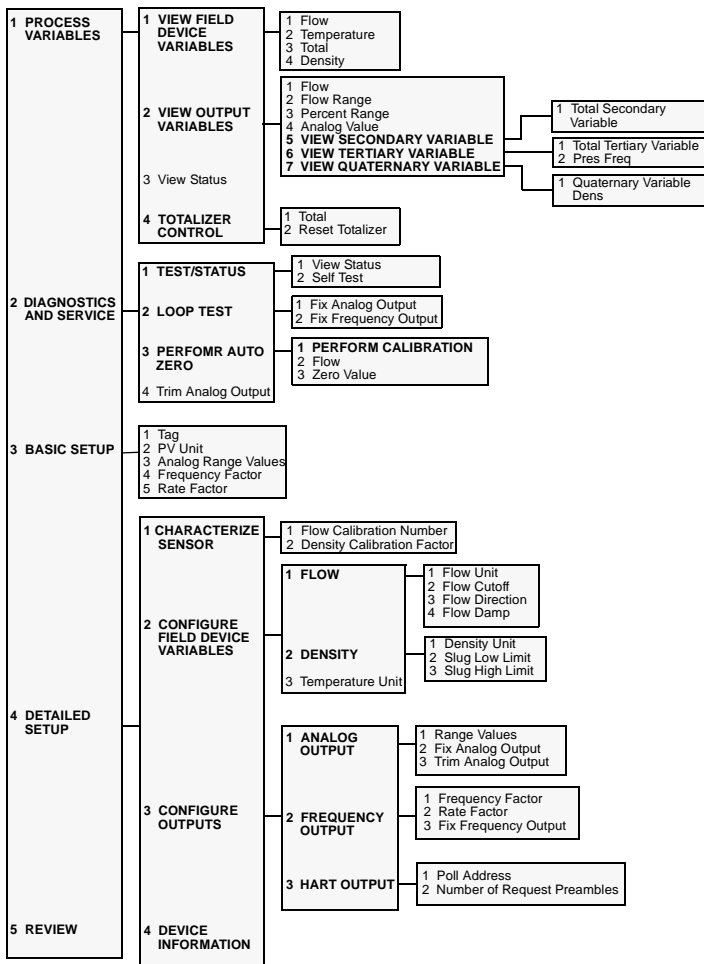

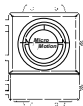

Model 9712 Mass Flowmeter

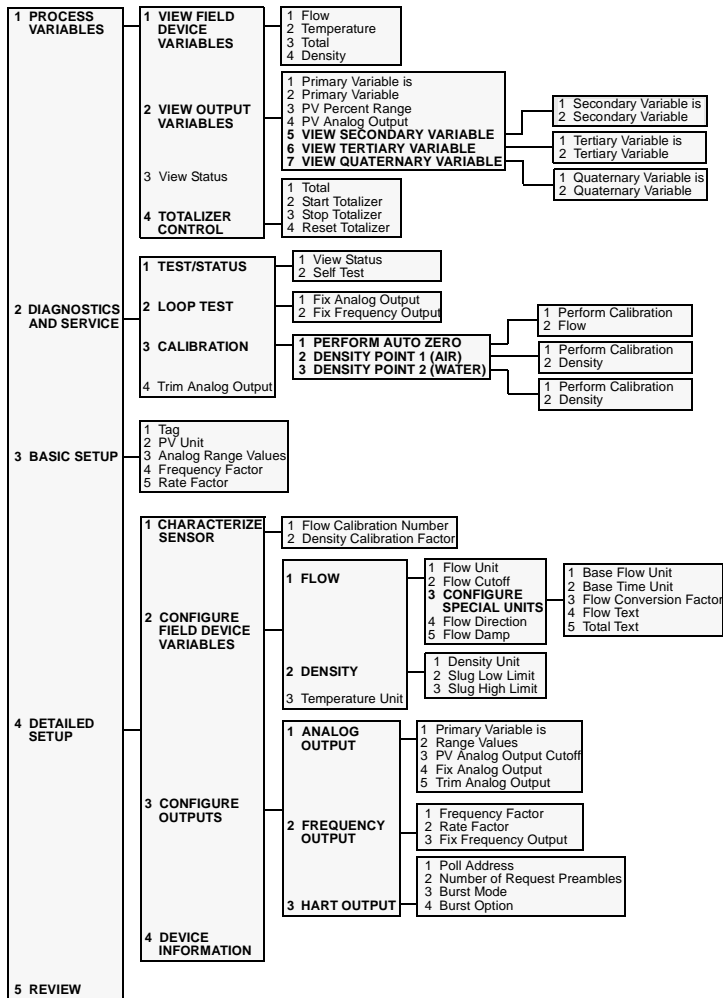



Model 9739 Mass Flowmeter

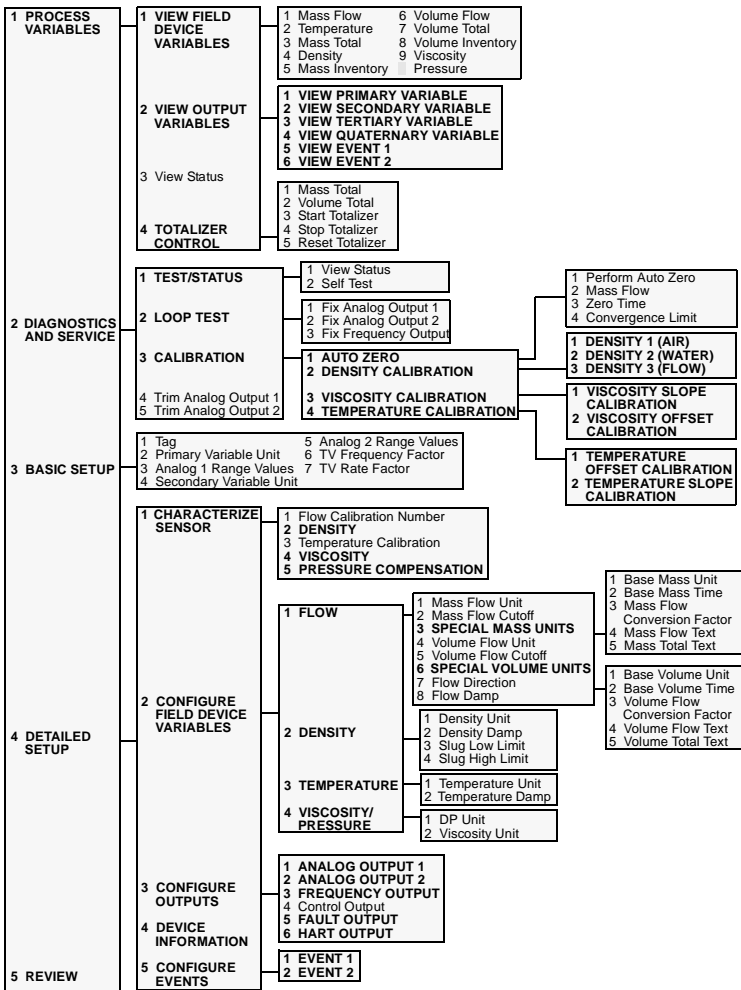



Model APEX Radar Level Gauge

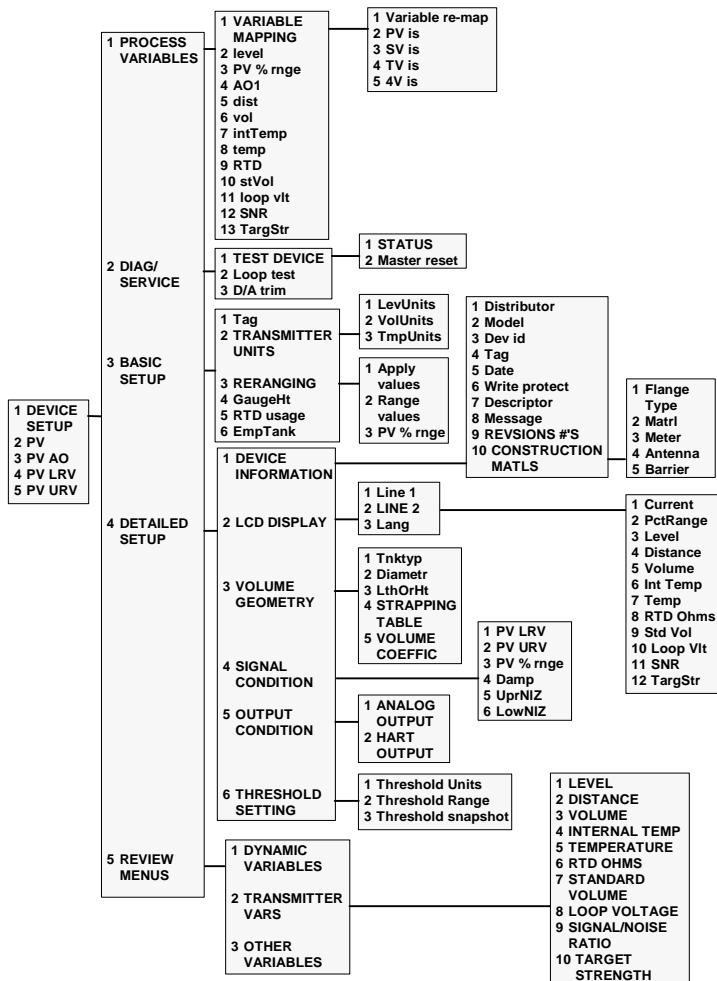



Model ProBar™ DP Flowmeter

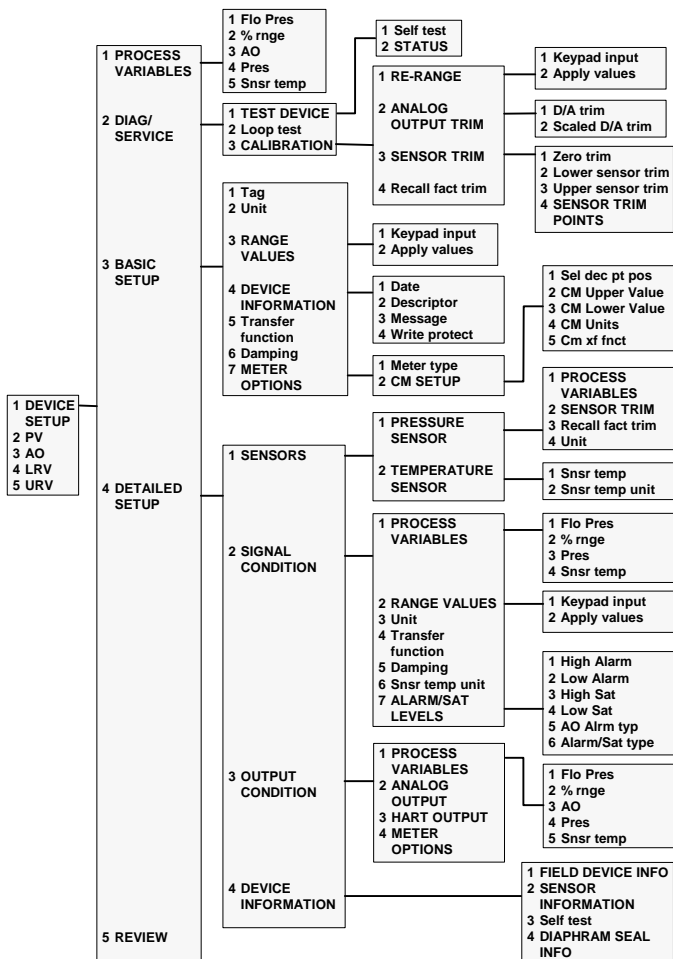



Model ProBar™ UC Flowmeter

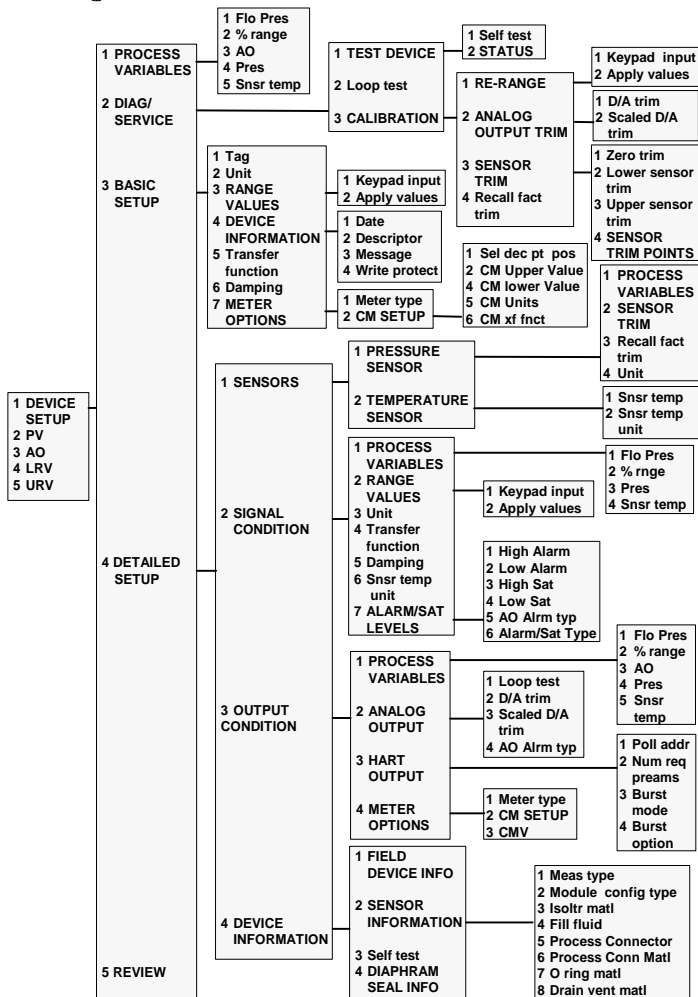



Model Tri-20/9000 Oval Flowmeter

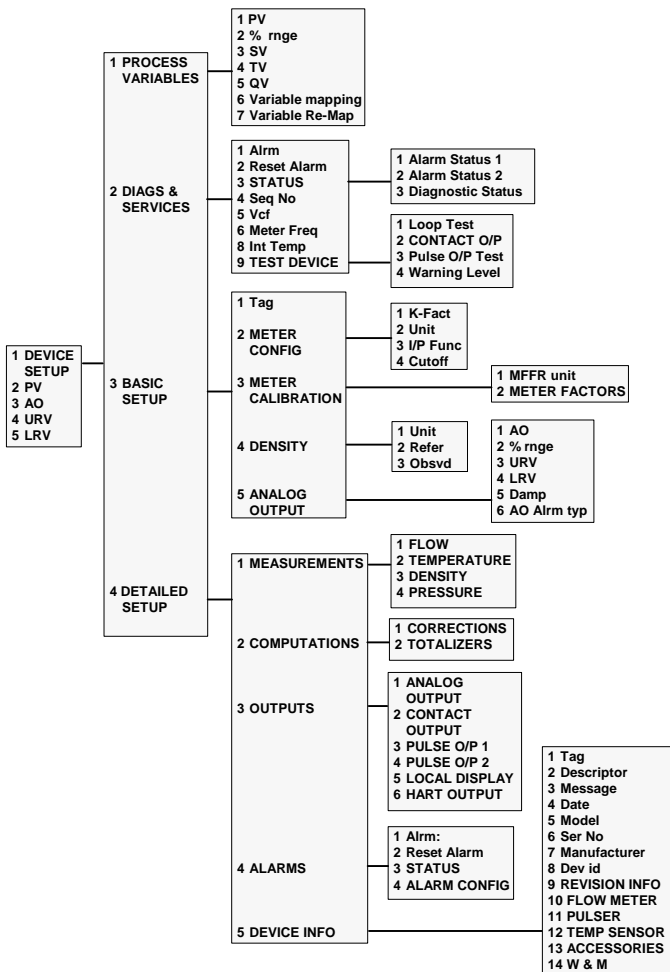

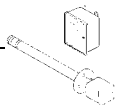

Model WC3000 Oxygen Analyzer

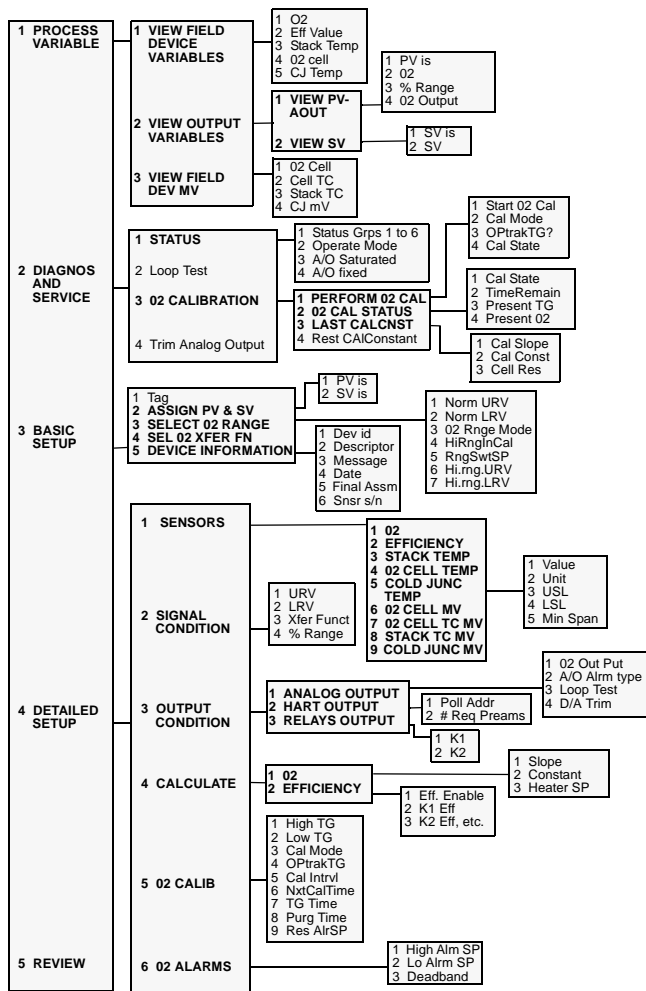

APPENDIX A

HART Communicator Messages

The following is a list of messages used by the HART Communicator (HC) with their corresponding descriptions.

- Variable parameters within the text of a message are indicated with *<variable parameter>*.
- Reference to the name of another message is identified by *[another message]*.

Message	Description
Add item for ALL device types or only for this ONE device type.	Asks the user whether the Hot Key item being added should be added for all device types or only for the type of device that is connected.
All variables associated with this variable must be marked or not marked the same.	This occurs if you marked one or more earlier variables and try to leave the current one unmarked. If you answer "Yes", then earlier variables will be marked or unmarked the same as the current variable.
Command Not Implemented	The connected device does not support this function.
Comm error associated with host comm port	HC cannot understand the response from the device.
Comm error associated with field device comm port	The device sends back a response indicating the message it received was unintelligible.
Compacting Memory. May require up to <nbr> minutes to complete.	When electrically erasable (EE) memory becomes fragmented, the empty spaces are gathered to form one large empty space so that a configuration can be stored. This takes time.
Compare: List of marked variables are not the same.	Results of compare function.
Configuration memory not compatible with connected device	The configuration stored in memory is incompatible with the device to which a transfer has been requested.
Device Busy	The connected device is busy performing another task.

Message	Description
Device Disconnected	Device fails to respond to a command.
Device write protected	Device is in write-protect mode. Data can not be written.
Device write protected. Do you still want to shut off?	Device is in write-protect mode. Press YES to turn the HC off and lose the unsent data.
Display value of variable on Hotkey menu?	Asks whether the value of the variable should be displayed adjacent to its label on the Hotkey menu if the item being added to the Hotkey menu is a variable.
Download data from configuration memory to device	Prompts user to press SEND softkey to initiate a memory to device transfer.
Exceed field width	Indicates field width for the current arithmetic variable exceeds that specified in the device description edit format.
Exceed precision	Indicates precision for the current arithmetic variable exceeds that specified in the device description edit format.
Ignore next 50 occurrences of status?	Asked after displaying device status. Softkey answer determines whether next 50 occurrences of device status will be ignored or displayed.
Illegal character	An invalid character for the variable type was entered.
Illegal date	The day portion of the date is invalid.
Illegal month	The month portion of the date is invalid.
Illegal year	The year portion of the date is invalid.
Incomplete exponent	The exponent of a scientific notation floating point variable is incomplete.
Incomplete field	The value entered is not complete for the variable type.
Insufficient space to store configuration	The Memory Module or data pack does not have enough memory to store the new configuration.
Looking for a device	Polling for multidropped devices at addresses 1–15.
Mark as read only variable on Hot key menu?	Asks whether the user should be allowed to edit the variable from the Hot key menu if the item being added to the Hot key menu is a variable.
No device configuration in configuration memory	There is no configuration saved in memory available to re-configure off-line or transfer to a device.

Message	Description
No device description for configuration in offline storage	Due to a stored configuration created in the presence of a DD not now available.
No device description for device at address <nbr>.	The Communicator has not been programmed with a device description that it can use to communicate with the device it found at the indicated polling address. The device information (manufacturer ID, device ID, device revision) is also displayed.
No Device Found	Poll of address zero fails to find a device, or poll of all addresses fails to find a device if auto-poll is enabled.
No Device found at address 0. Poll?	The polling option is set to ask before polling.
No Hotkey menu available for this device.	There is no menu named "Hotkey" defined in the device description for this device.
No offline devices available.	There are no device descriptions available to be used to configure a device offline.
No online device connected. Do you still want to turn off?	Communicator is set up to send configuration to online device. The device is not connected and you pressed off key before sending. You are being asked if OK to turn off.
No simulation devices available.	There are no device descriptions available to simulate a device.
No UPLOAD_VARIABLES in ddl for this device	There is no menu named "upload_variables" defined in the device description for this device. This menu is required for offline configuration.
No Valid Items	The selected menu or edit display contains no valid items.
NOTICE: There are dependent variables for this unit variable.	When marking offline variables, there are other variables that depend on this variable.
NOTICE: Unit relation variables will also be unmarked.	If the unit variable is marked then unmark the relation variable. The unit will be unmarked automatically.
NOTICE: The unit variable for this variable is unmarked.	The variable is marked as part of a relation and the unit is not yet marked. That is, the range may be sent to a device with units that are not the same as what is stored offline.
NOTICE: Upgrade 275 software to access new connected device functions. Continue with old description?	You have connected to a device that is a newer revision than what is linked into the HC.

Message	Description
OFF KEY DISABLED	Appears when the user attempts to turn the HC off before sending modified data or before completing a method.
Online device disconnected with unsent data. RETRY or OK to lose data.	There is unsent data for a previously connected device. Press RETRY to send data, or press OK to disconnect and lose unsent data.
Out of memory for Hotkey configuration. Delete unnecessary items.	There is no more memory available to store additional Hot Key items. Unnecessary items should be deleted to make space available.
Overwrite existing configuration memory	Requests permission to overwrite existing configuration either by a device-to-memory transfer or by an offline configuration. User answers using the softkeys.
Press OK...	Press the OK softkey. This message usually appears after an error message from the application or as a result of HART communications.
Restore device value?	The edited value that was sent to a device was not properly implemented. Restoring the device value returns the variable to its original value.
Save data from device to configuration memory	Prompts user to press SAVE softkey to initiate a device-to-memory transfer.
Saving data to configuration memory.	Data is being transferred from a device to configuration memory.
Sending data to device.	Data is being transferred from configuration memory to a device.
All variables associated with this variable must be marked or not marked the same. Change others?	This occurs if you marked one or more earlier associated variables and try to leave the current one unmarked, or if you unmarked one or more earlier associated variables and try to leave the current one marked. If you answer "Yes" then earlier variables will be marked or unmarked the same as the current variable.
Sort allows you to group and display configurations by their Descriptor, Tag, or Name.	Allows you to customize your menu displays with the sort option. It is accessed through Saved Configurations and operates in conjunction with the Filter option.

Message	Description
Specified filter passes no configurations. Filter reset to '*'	The filter automatically reset to all '*'. This is due to being too restrictive while filtering a table of contents.
Storage location write protected	The rated life of the EEPROM could be used up. Contact your service representative.
Some variables in this saved configuration were not marked because they were not read.	This configuration contains write-only variables which cannot be read. The user must mark and edit these variables before they will be sent down to a device.
There is unsent data. Send it before shutting off?	Press YES to send unsent data and turn the HC off. Press NO to turn the HC off and lose the unsent data.
Too few data bytes received.	Command returns fewer data bytes than expected as determined by the device description.
Field Device Fault.	Device returns a command response indicating a fault with the connected device.
Units for <variable label> has changed. Unit must be sent before editing, or invalid data will be sent.	The engineering units for this variable have been edited. Send engineering units to the device before editing this variable.
Unsent data to online device. SEND or LOSE data.	There is unsent data for a previously connected device which must be sent or thrown away before connecting to another device.
Use up/down arrows to change contrast. Press DONE when done.	Gives direction to change the contrast of the HC display.
Value out of range	The user-entered value is either not within the range for the given type and size of variable or not within the min/max specified by the device.
<message> occurred reading/writing <variable label>	Either a read/write command indicates too few data bytes received, transmitter fault, invalid response code, invalid response command, invalid reply data field, or failed pre- or post-read method; or a response code of any class other than SUCCESS is returned reading a particular variable.

Message	Description
<variable label> has an unknown value. Unit must be sent before editing, or invalid data will be sent.	A variable related to this variable has been edited. Send related variable to the device before editing this variable.

APPENDIX B

Specifications and Ordering Information

FUNCTIONAL SPECIFICATIONS

Memory

Nonvolatile memory retains contents when the HART Communicator is not powered.

Program and Device Descriptions:	12 MB (standard) 4 MB (optional)
Field Device Data:	2 KB
data pack 100 (optional):	32 KB removable nonvolatile memory

Power Supply

Five AA 1.5 V batteries (rechargeable NiCad battery pack optional).

Battery Charger Options

110/120 V ac, 50/60 Hz, U.S. plug
220/230 V ac, 50 Hz, European plug
220/230 V ac, 50 Hz, U.K. plug

Microprocessors

32-bit Motorola type 68331
16-bit Motorola type 68HC705

Connections

Battery charger:	2.5 mm jack
Leadset:	Two 4 mm banana plugs
Memory Module:	26 pin, 0.1-in. Berg connector
Serial port:	PC connected through optional PC Communication Adapter

PERFORMANCE SPECIFICATIONS

Electromagnetic Compatibility (EMC)

EMC compliant only when the CE mark appears on both the keypad assembly and Memory Module.

Humidity Limits

Operates in 0–95% relative humidity under noncondensing conditions over the entire operating range of 32 to 122 °F (0 to 50 °C).

Hazardous Locations Certifications

CENELEC—Intrinsic Safety Certification

Factory Mutual (FM)—Intrinsic Safety Approval

Canadian Standards Association (CSA)—Intrinsic Safety Approval

ISO 9001 Approval

The Model 275 HART Communicator is built by an ISO 9001 approved system.

Operating Limits

32 to 122 °F (0 to 50 °C).

Storage Limits

–4 to 158 °F (–20 to 70 °C).

PHYSICAL SPECIFICATIONS

Display

8-line liquid crystal display with 21-character line width (128 by 64 pixels).

Keypad

25 large keys including six Action keys, a complete alphanumeric keypad, four software-defined function keys, ON/OFF, and cursor control keys; membrane design with tactile feedback.

Weight

Approximately 3 lb. (1.4 kg) with NiCad battery pack.

ORDERING INFORMATION

The following table lists standard and optional product selections.

Model	Product Description
275	HART Communicator*
Code	Battery Pack Option
D	Battery Holder for Disposable AA Batteries
R	Rechargeable NiCad Battery Pack
Code	Recharger Service and Plug Type
1	100/120 V ac, 50/60 Hz, U.S. Plug
2	220/230 V ac, European Plug
3	220/230 V ac, U.K. Plug
9	None
Code	Language
E	English
F	French
G	German
J	Japanese
Code	Hazardous Locations Certifications
I0	No Approval
I1	British Approvals Service for Electrical Equipment in Flammable Atmospheres (BASEEFA)/CENELEC Intrinsic Safety Certification
I5	Factory Mutual (FM) Intrinsic Safety Approval
I6	Canadian Standards Association (CSA) Intrinsic Safety Approval
Code	Memory Module Type
B	4 MB Memory Module
D	12 MB Memory Module (Standard)
Code	Device Description Options
00	Standard Factory Loading
Code	Future Option
D1	Shipped with one (1) data pack 100 installed
D2	Shipped with two (2) data pack 100's
00	Shipped without data pack 100
Typical Model Number: 275 D 9 E I5 D 00 00	

*Typical Model 275 D 9 E I5 D 00 00 includes HART Communicator, AA battery pack with batteries, leadset with MINI GRABBERS™ and alligator clips, carrying case, FM Intrinsic Safety Approval, and pocket-sized instruction manual.

Options include: NiCad battery pack with recharger, language, certifications, and data pack 100. If the NiCad battery pack is selected, one spare battery pack per HART Communicator is recommended.

Spare Parts

Refer to the following table and exploded view to choose spare parts and accessories for the HART Communicator.

	Part Number	Description
①	00275-0170-0100	AA Alkaline Battery Pack for Code I0
①	00275-0170-0101	AA Alkaline Battery Pack for Code I1
①	00275-0170-0102	AA Alkaline Battery Pack for Code I5
①	00275-0170-0103	AA Alkaline Battery Pack for Code I6
①	00275-0171-0100	NiCad Battery Pack for Code I0
①	00275-0171-0101	NiCad Battery Pack for Code I1
①	00275-0171-0102	NiCad Battery Pack for Code I5
①	00275-0171-0103	NiCad Battery Pack for Code I6
	00275-0007-0001	Recharger 220/230 V ac (U.K. plug)
	00275-0007-0002	Recharger 220/230 V ac (European plug)
	00275-0007-0003	Recharger 100/120 V ac, 50/60 Hz (U.S. plug)
②	00275-0003-0300	Memory Module 4 MB
②	00275-0003-0700	Memory Module 12 MB (Standard)
③	00275-0006-0100	Fisher-Rosemount data pack 100
④	00275-0095-0001	Belt Clip with Screws
⑤	00275-0094-0001	Hanger (mounts on belt clip option)
⑥	00275-0013-0001	PC Communication Adapter ⁽¹⁾
⑦	00275-0096-0001	Ruggedized 250 Ohm Load Resistor
⑧	00275-0093-0001	Lead Set with Connectors
⑨	00275-0100-0001	Carrying Case
⑩	00275-8026-0002	Pocket-size Manual
	00275-8072-0001	PC Cable (DB9 to DB25) ⁽¹⁾

⁽¹⁾ Requires Asset Management Solutions (AMS) software with 275 Interface Kit option.

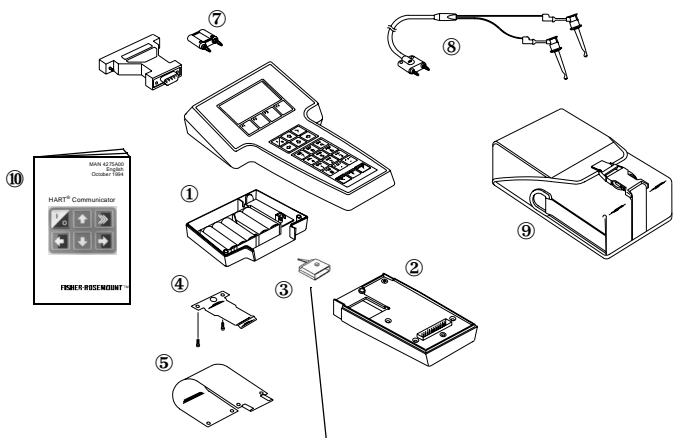

275-0275J01A, 0275I01A, 0275L01A

data pack 100:
Stores up to 100 typical
device configurations in
removable, nonvolatile memory.

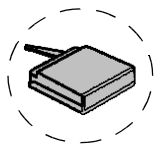

- NOW YOU CAN:**
- Create configurations offline
 - Store data safely
 - Transfer data easily

APPENDIX C

CSA and FM Intrinsic Safety Approvals

CANADIAN STANDARDS ASSOCIATION (CSA)

The 275 is intrinsically safe for use in Class 1, Division 1, Groups A, B, C, and D hazardous locations when connected to CSA certified intrinsic safety barriers as indicated in the recreated connection diagram drawing displayed below.

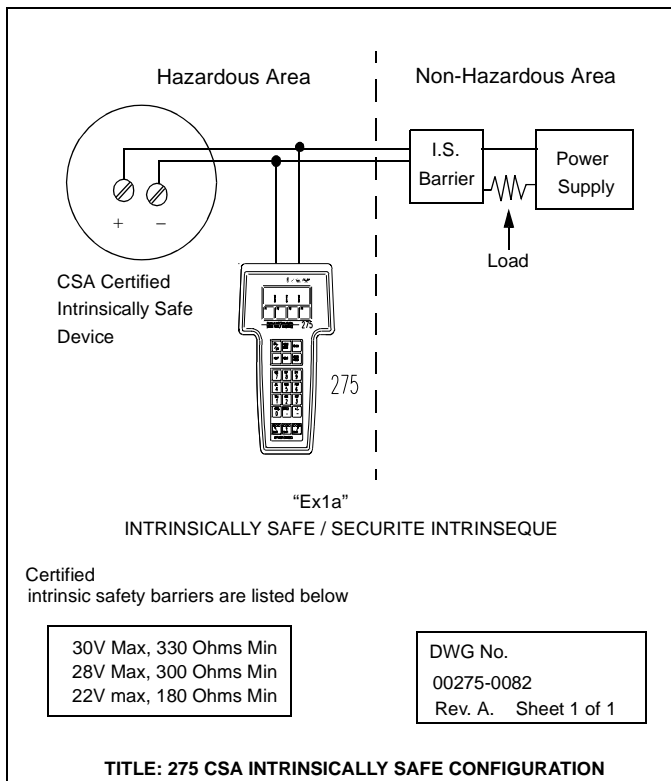

FACTORY MUTUAL (FM)

The FM entity parameters listed in Table 1 only apply to associated apparatus with linear output.

DWG No. 00275-0081 Rev. D. Sheet 1 of 2

Table 1: FM Entity Parameters

Input Parameters	Class I, Div. 1, Groups A, B, C, D
$V_{max} = 30 \text{ V}_{dc}$	V_T or V_{oc} of barrier must be $\leq 30 \text{ V}_{dc}$
$I_{max} = 300 \text{ mA}$	I_T or I_{sc} of barrier must be $\leq 300 \text{ mA}$
$C_i = 0.07 \mu\text{F}$	C_A of barrier must be $\geq 0.07 \mu\text{F}$
$L_i = 0 \text{ mH}$	L_A of barrier must be $\geq 0 \text{ mH}$
Output Parameters	
$V_{oc} = 1.7 \text{ V}_{dc}$	N/A
$I_{sc} = 32 \text{ mA}$	N/A

Before connecting the model 275 into the loop, determine the connected inductance of the system by adding the L_i of the transmitter and cable.

The sum must be less than the L_a , as determined from Table 2, before the 275 can be connected into the loop.

If the connected inductance is greater than the value determined from the table, a barrier with a lower I_{sc} must be chosen.

Table 2: Maximum Allowable Connected Inductance

I_m (mA)	L_a (mH)		
	Groups A & B	Group C	Group D
300	0.20	1.80	3.20
280	0.21	2.00	3.70
270	0.23	2.20	3.90
260	0.25	2.50	4.30
250	0.27	2.70	4.60
240	0.30	3.00	5.00
220	0.40	3.20	5.90
200	0.50	4.00	7.20
180	0.60	5.00	8.80

Table 2: Maximum Allowable Connected Inductance

I_m (mA)	La (mH)		
	GROUPS A & B	GROUP C	GROUP D
170	0.80	5.50	9.90
160	1.00	6.20	11.20
150	1.30	7.00	12.70
140	1.60	8.00	14.60
130	2.00	9.00	16.90
120	2.50	10.00	19.80
110	3.00	12.00	23.60
100	4.00	15.00	28.50
90	5.00	18.00	35.10
85	5.50	20.00	39.30
80	6.00	22.00	44.40
75	6.70	25.00	50.50
70	7.50	28.00	57.90
65	8.80	34.00	67.10
62	9.50	37.00	73.70
60	10.00	40.00	78.70
57	11.00	43.00	87.10
55	12.00	48.00	93.50
50	15.00	56.00	113.10
45	19.00	70.00	139.40
40	23.00	87.00	176.30
35	31.00	110.00	229.90
32	36.00	135.00	274.80
30	40.00	150.00	312.40
28	46.00	170.00	358.40
25	58.00	210.00	449.00
23	68.00	250.00	530.10
21	82.00	300.00	635.30
20	90.00	330.00	700.00

NOTE: $I_m = I_{scBarrier} + I_{sc275} = I_{scBarrier} + 32mA$

DWG No. 00275-0081 Rev. D. Sheet 1 of 2

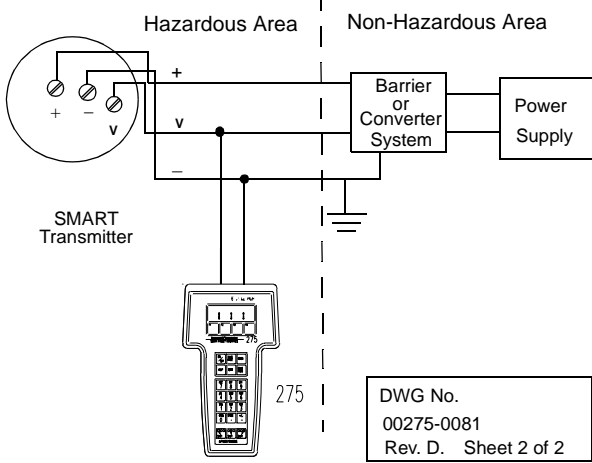
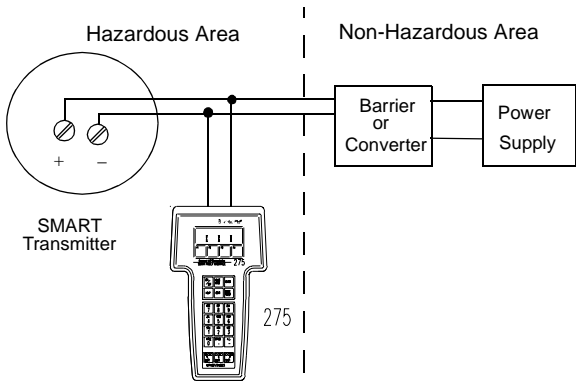

TITLE: Model 275 FM IS Installation Drawings

APPENDIX D

Troubleshooting Communication Problems

This section contains troubleshooting steps you can take if you are experiencing communications problems between a field device and your HART Communicator.

Problem	Possible Cause	Possible Solution
Intermittent communication	Insufficient loop resistance at the HART frequencies.	Add an additional 250 ohm resistor in series in the loop. Place the HART Communicator leads across the resistor and verify if communication has been restored.
	Noise on the field loop	Verify field wiring shield is grounded at one end only. Normally, the shield is grounded at the control system and floating at the field device. See diagram following this table.
	Noise or signal distortion from the control system (i.e., noise from power supply powering field devices or front end analog circuitry inside of control system may be distorting the HART signal).	<p>Remove field wiring and power loop with external power supply and a 250 resistor in the loop. Verify if communication is restored with this configuration. If yes, an oscilloscope may be used to inspect possible noise or signal distortion from the control system. Noise of interest would be in the 800 Hz to 10 KHz range with an amplitude of 0.5Vpp or larger. Larger amplitudes below 800 Hz or above 10 KHz may also affect communication.</p> <p>Place a 0.1 microfarad (μf) to a 0.22 μf (Capacitor parameters: working voltage: 50V DC and no polarity) across the control system terminals. Verify if communication is restored. If not, place a 250 ohm resistor in series and verify if communication is restored. See diagram following this table.</p>

Problem	Possible Cause	Possible Solution
No communication with field device	Insufficient loop resistance at the HART frequencies.	Add an additional 250 ohm resistor in series in the loop. Place the HART Communicator leads across the resistor and verify if communication has been restored.
	Insufficient loop current and voltage at the field device terminals.	Verify that there is at least 4mA and 12V DC at the field device terminals.
	Field device may be set to HART address other than zero (multi-drop mode).	Change 275 mode to digital polling.
Control system is communicating HART, but the 275 is not communicating properly	HART communication with the HART Communicator is being prevented by the control system	Stop HART communications on the control system and verify if communication between the field devices and HART Communicator is restored.
Battery pack does not accept a charge	Battery pack has been discharged past the normal range.	Remove battery pack and recharge while it is disconnected from the Communicator.

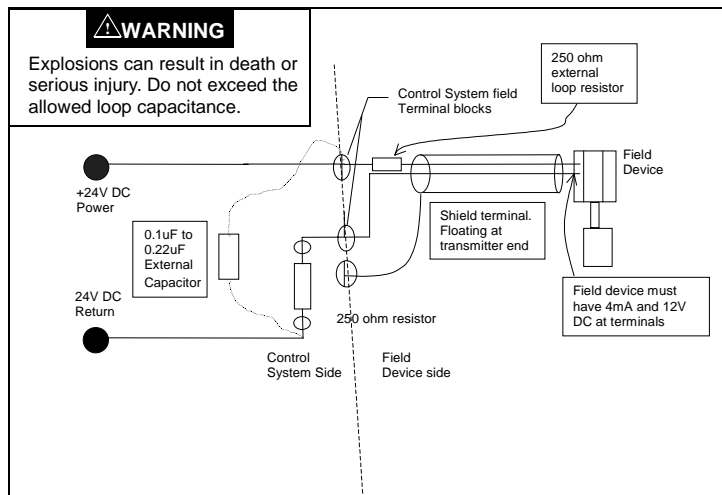

IF YOU ARE STILL HAVING PROBLEMS

If you have already gone through the Troubleshooting table on the previous pages and are still having problems, contact Fisher-Rosemount technical support at 1-800-833-8314 or 1-512-832-3774. Please complete the following check list and have the following information available.

Information	Notes
Manufacturer and model of the control system.	
Manufacturer and model of the field device.	
Loop diagram of the problem loop.	
Plant layout and proximity to other equipment.	
Do HART communications occur when other devices or processes are not running?	
Total cable length from the termination panel to the field device.	
Message on the Communicator screen when attempting to communicate with the field device (e.g., device not found).	
Task performed when a specific error message was displayed.	
Number of HART loops in the facility.	
Number of HART loops that are failing (i.e., no communication).	

For further information on the HART Communicator, contact our web address at www.hartcommunicator.com.

INDEX

A

- Accessories B-4
- Action Keys
 - Arrow Keys 1-5, 1-6
 - Cursor Keys 1-6
 - Hot Key 1-6
 - Left Arrow Key 1-6
 - On/Off Key 1-5
 - Previous Menu Key 1-6
 - Right Arrow Key 1-6
 - Select Key 1-6
 - Up Arrow Key 1-6
- Alphanumeric Keys 1-8
- Always Poll 1-23
- AMS Software 1-18, 1-26, 1-27, 1-28, 1-29
- Analog Output (AO) 1-20, 2-3
- Ask before Polling 1-23
- Asset Management Solutions (AMS) 1-26
- Automatic Turn Off 1-24

B

- Basic Setup 2-5
- Battery Pack 1-35
 - Changing Alkaline Batteries 1-36
 - Recharging NiCad Battery Pack 1-37

C

- Calibration 1-35
- CE Approval B-2
- Changing Stored Configurations 1-29
- Communication Adaptor 1-2, 1-27, B-1
- Communication Problems D-1
- Communicator Messages A-1
- Communicator, HART 1-10
- Compare 1-19
- Configuration Parameters 1-20
- Connections
 - Connection Diagram 1-2
 - Load Resistance 1-4
 - Rear Connection Panel 1-2
 - Wiring Connections 1-2
- Contrast 1-24
- Copy To 1-18
- CSA Intrinsic Safety Connection 1-4
- CSA Intrinsic Safety Approvals C-1

D

- Data Entry 1-9

- data pack 100 1-1, B-4
- Data Type 1-16
- Delete 1-18
- Detailed Setup 2-5
- Device 1-20
- Device Descriptions 1-12
- Device Setup 1-20, 2-2
- Device Setup Menu 2-4
- Diagnostics and Service 2-4
- Digital Poll 1-23
- Disabled Off Key 1-5

E

- Edit 1-18
- Edit Individually 1-15
- Electromagnetic Compatibility (EMC) B-2
- EMC Compliance B-2
- Expand 1-18

F

- Fast Key Sequence 2-6
- Fast Select 1-8
- FM Intrinsic Safety Approvals C-2
- FM Intrinsic Safety Connections 1-4
- Frequency Device Menu 1-21
- Function Key Labels 1-7
- Function Keys 1-6
 - Help Key 1-6
 - Home Key 1-7

G

- Generic Online Menu Tree 1-20
- Graphic Symbols 1-10

H

- Hazardous Locations Certifications B-2
- HOME Key 1-7
- Hot Key 1-6
 - Customizing the Hot Key Menu 1-31
 - Deleting Options 1-33

I

- Icons
 - Software 1-10
- Ignore Diagnostics 1-25
- Intrinsic Safety Approvals B-3, C-1
- ISO 9001 Approved B-2

K

Keypad

- Action Keys 1-5
- Alphanumeric keys 1-8
- Function Keys 1-6
- Hot Key 1-6
- Shift Keys 1-9

L

- Language Options B-3
- Liquid Crystal Display 1-4
- Listen for PC 1-17, 1-26
- Load Resistor 1-4, B-4
- Lower Range Value (LRV) 1-20, 2-3

M

- Main Menu 1-9, 1-12
- Memory Module 1-37
 - Replacing the Memory Module 1-38
- Menu Icons 1-10
- Menu Structure 1-11
- Messages A-1
- Microprocessors B-1
- Model Number B-3
- Model-Specific Routine Tasks 3-1

N

- Never Poll 1-23
- NIST 1-35

O

- Off Key Disabled 1-5
- Offline Configure
 - Field Device Revision Menu 1-14
 - Manufacturer Menu 1-14, 1-28
 - Model Menu 1-14
- Offline Connections 1-9
- Offline Menu
 - New and Saved Configurations 1-13
- Offline Menu Tree 1-13
- ON/OFF Key 1-5
- Online Connections 1-9
- Online Help 1-6
- Online Menu 1-9
- Ordering Information B-3

P

- PC Interface 1-26
- Poll Using Tag 1-23
- Polling 1-23

- Power Supply 1-10
- Primary Variable (PV) 1-20, 2-3
- Process Variables 2-4

R

- Recharging Batteries 1-37
- Rename 1-19
- Resistance in the Loop 1-3
- Resistor 1-4, B-4
- Reviewing Installed Devices 1-12

S

- Save 1-20
- Save As 1-16
- Save to data pack 1-16
- Save to Module 1-16
- Saved Configuration 1-17, 1-18
- Send 1-18
- Servicing the HART Communicator
 - Disassembly 1-35
 - Memory Module 1-37
- Shift Keys 1-8
- Simulation 1-28
- Software Icons 1-10
- Specifications
 - Hazardous Locations
 - Certifications B-2
 - Performance B-2
 - Physical B-2
- Storage Location 1-28
 - Module and Data Pack 1-16

T

- Tag 1-5
- Troubleshooting D-1

U

- Unmark All 1-15
- Upgrading Software 1-35
- Upper Range Value (URV) 1-20, 2-3
- Utility Menu 1-22
 - Auto Poll 1-22
 - Contrast Adjustment 1-24

W

- Wiring
 - Load Resistance 1-4

Y

- Year 2000 Compliance 1-34